

**Orthopaedics**

# SECTION - 09

## ORTHOPAEDICS



# Orthopaedics



**ST.THOMAS**  
09-001-160  
16.0 cm  
Pointed



**ST.THOMAS**  
09-002-160  
16.0 cm  
Rounded



**ROBINSON'S**  
09-003-170  
17.0 cm



**WILLIGER**  
09-004-160  
16.0 cm



**LANE**  
09-005-160  
16.0 cm  
Serrated



**LANE**  
09-006-270  
27.0 cm



**TRETHOWAN'S**  
09-007-220  
22.0 cm



**BRISTOW'S**  
09-008-240  
24.0 cm



**SEDILLOT**  
09-009-210  
21.0 cm



**LANGENBECK**  
09-010-180  
18.0 cm

**Orthopaedics**



**LANGENBECK**  
**09-011-190**  
19.0 cm



**HOHMANN**  
**09-012-150**  
15.0 cm



**HOHMANN**  
**09-013-154**  
15.4 cm  
Short tip



**PERIOSTEAL ELEVATOR**  
17.5 cm  
For metacarpals Small  
6 mm width ( Fig 1 )  
For metacarpals Medium  
10 mm width ( Fig 2 )  
Light Curve, Rounded End,  
5 mm width ( Fig 3 )  
Contra Angled Curve  
4.5 mm width ( Fig 4 )

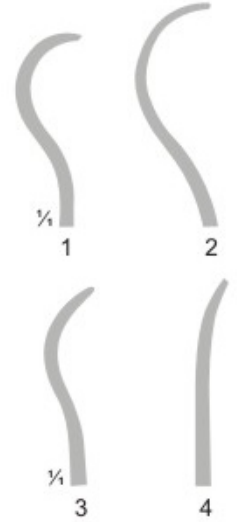

**BUCK GRAMCKO**  
**09-018-180** 18.0 cm  
Small, width 6 mm  
short, narrow tip



**BUCK GRAMCKO**  
**09-019-180** 18.0 cm  
Small, width 8 mm  
short, narrow tip



**HOHMANN**  
**09-020-200** 20.0 cm  
width 8 mm  
short, narrow tip



**HOHMANN**  
**09-021-200** 20.0 cm  
width 18 mm short, narrow tip  
**09-022-200** 20.0 cm  
width 18 mm short, narrow tip



**HOHMANN**  
**09-023-160** 16.0 cm  
For small Fragments  
Board Shank



**Orthopaedics**



**HOHMANN**  
**09-024-180** 18.0 cm  
Width 43 mm  
narrow tip  
**09-025-180** 18.0 cm  
Width 70 mm  
narrow tip



**HOHMANN**  
**09-026-180** 18.0 cm  
Width 43 mm  
Long shank, angled



**HOHMANN**  
**09-027-160** 16.0 cm  
Width 22 mm wide tip



**HOHMANN**  
**09-028-160** 16.0 cm  
Long wire tip for Hip  
Surgery, width 24 mm

**Orthopaedics**



**09-030-190** 19.0 cm, 13 mm  
**09-031-200** 20.0 cm, 20 mm  
**09-032-230** 23.0 cm, 25 mm  
**09-033-250** 25.0 cm, 31 mm

**HANDLER**  
**09-029-250**  
 25.0 cm



**HOEN PERIOSTEAL**  
**09-034-165**  
 16.5 cm



**KEY PERIOSTEAL**  
**09-035-180**  
 18.0 cm Tip 1/2"



<b>09-036-190</b>	19 cm	03 mm
<b>09-037-190</b>	19 cm	06 mm
<b>09-038-190</b>	19 cm	09 mm
<b>09-039-190</b>	19 cm	12 mm
<b>09-040-190</b>	19 cm	15 mm
<b>09-041-190</b>	19 cm	19 mm
<b>09-042-190</b>	19 cm	25 mm

**KEY**



**COBB**  
 Elevators  
**09-049-234**  
 23.4 cm  
 Hex Handle



**SEM B**  
**09-043-195**  
 19.5 cm



**09-044-195**



**09-045-195**



**09-046-195**

**7 STELLA**  
 Veterinary Surgical Instruments

**Orthopaedics**



**09-047-200**  
20.0 cm  
Medium Straight  
blade round edge,  
width 14 mm



**09-048-200**  
20.0 cm  
Medium Curved  
blade round edge,  
width 14 mm



**09-049-180**  
18.0 cm  
Small Curved  
blade round edge,  
width 6 mm



**09-050-180**  
18.0 cm  
Small Curved  
blade round edge,  
width 6 mm



**09-051-180**  
18.0 cm  
Extra Small  
Curved blade  
round edge,  
width 3 mm



**09-052-200**  
20.0 cm  
Large Straight  
blade round edge,  
width 20 mm



Straight Edge, 14 mm  
**09-053-185**  
Straight 18.5 cm  
**09-054-185**  
Curved 18.5 cm



**LAMBOTTE** 21.0 cm  
**09-055-210** 1.0 cm  
**09-056-210** 1.5 cm  
**09-057-210** 2.0 cm



**LAMBOTTE**  
**09-058-150**  
15.0 cm



**FARABEU**  
**09-059-150**  
15.0 cm



**MANNERFELT modif**  
**09-060-160** 5.0 mm  
**09-061-160** 6.0 mm  
**09-062-160** 7.0 mm  
**09-063-160** 16 mm

**Orthopaedics**



**GALLAHER**  
09-064-177  
17.7 cm



**PUTTI**  
09-065-280  
28.0 cm



**PUTTI**  
09-066-300  
30.0 cm



**BONE TAMP**  
09-067-154  
15.4 cm  
Tip Dia, 10 mm



**09-068-240**  
24.0 cm



**FOMAN RASP**  
09-069-210  
21.0 cm



**MILLER-COLBURN**  
18.0 cm

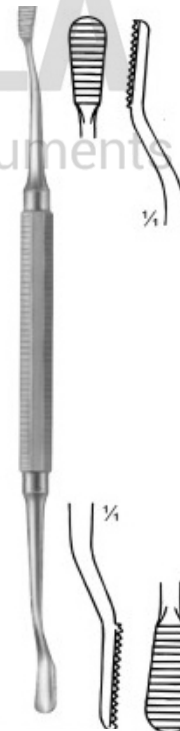
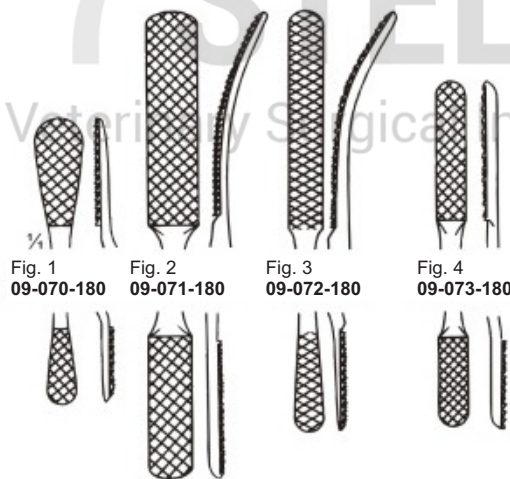



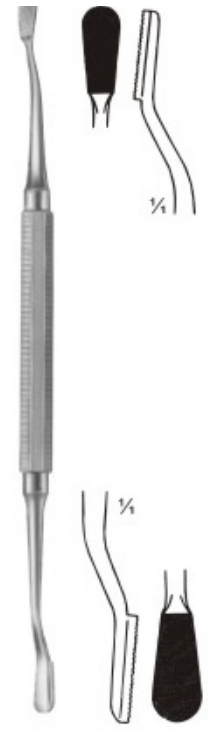





**MILLER FILE**  
09-074-190  
19.0 cm



**MILLER FILE**  
09-075-190  
19.0 cm





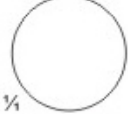





# Orthopaedics



 09-076-170 000	 09-077-170 00
 09-078-170 0	 09-079-170 1
 09-080-170 2	 09-081-170 3
 09-082-170 4	 09-083-170 5
 1/4 09-084-170 6	

**BRUNS**  
17.0 cm



 09-085-170 0000	 09-086-170 000	 09-087-170 00
 09-088-170 0	 09-089-170 1	 09-090-170 2
 09-091-170 3	 09-092-170 4	 09-093-170 5
 1/4 09-094-170 6		

**VOLKMANN**  
17.0 cm



Fig. 1  
09-095-240

Fig. 2  
09-096-240

Fig. 3  
09-097-240









Fig. 4  
09-098-240

Fig. 5  
09-099-240

Fig. 6  
09-100-240









**SIMON**  
24.0 cm



 09-101-225 22.5 cm 000	 09-102-225 22.5 cm 00
 09-103-225 22.5 cm 0	 09-104-225 22.5 cm 1
 09-105-225 22.5 cm 2	 09-106-225 22.5 cm 3
 09-107-225 22.5 cm 4	 09-108-225 22.5 cm 5
 1/4 09-109-225 22.5 cm 6	

**HIBBS-SPRRATT / ANGLED**



 09-110-225 22.5 cm 000	 09-111-225 22.5 cm 0
 09-112-225 22.5 cm 0	 09-113-225 22.5 cm 1
 09-114-225 22.5 cm 2	 09-115-225 22.5 cm 3
 09-116-225 22.5 cm 4	 09-117-225 22.5 cm 5
 1/4 09-118-225 22.5 cm 6	

**HIBBS-SPRRATT / STRAIGHT**



**UFFENORDE LEFT**  
09-119-175  
17.5 cm

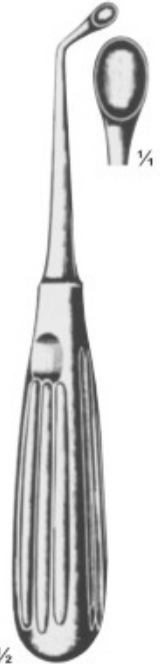

**UFFENORDE RIGHT**  
09-120-175  
17.5 cm



**Orthopaedics**

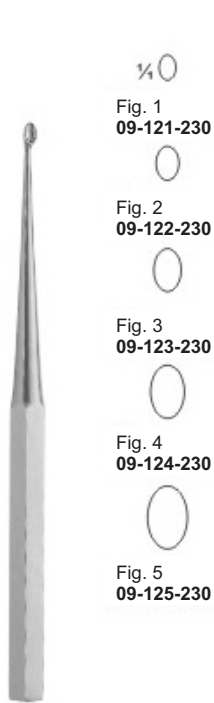

**BRUNS**  
23 cm

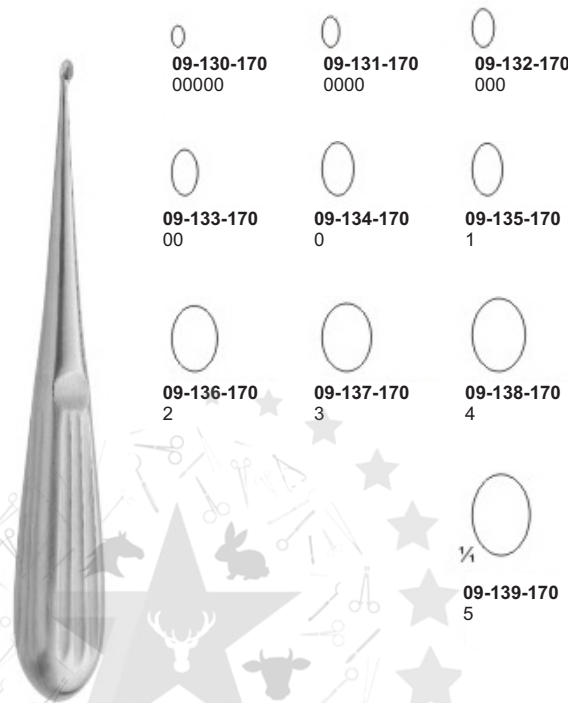
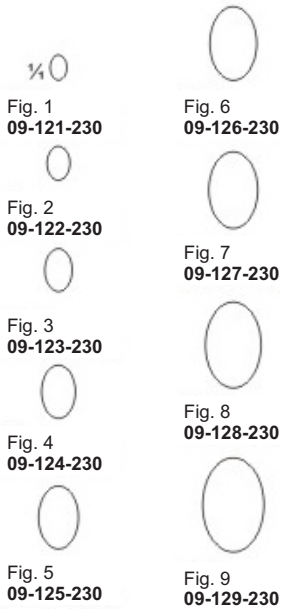

**SPRATT**  
17.0 cm

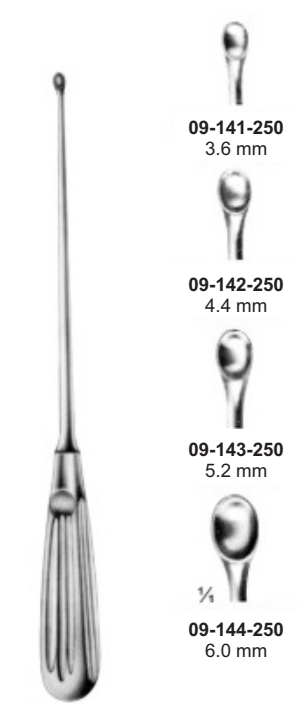
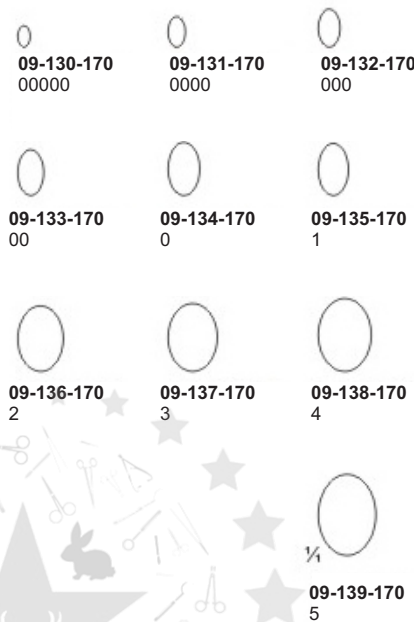

**09-140-250**  
25.0 cm



**FIBER HANDLE**  
27 cm

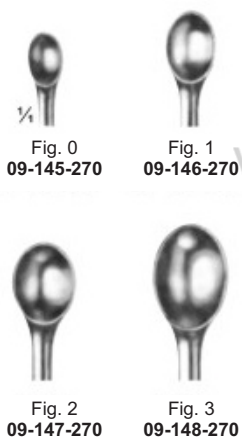

**SCOVILLE**  
27 cm

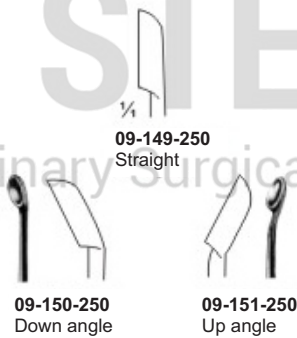

**LUCAS**  
double-ended  
09-152-180  
18.0 cm

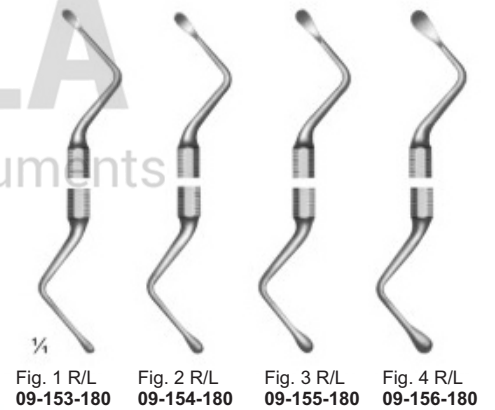

**Orthopaedics**



**WILLIGER**  
**09-157-133**  
13.25 cm  
Double ended  
00/0



**VOLKMANN**

**09-158-130**  
13.0 cm  
Double ended  
6.2 mm & 6.7 mm

**09-159-160**  
16.0 cm  
Double ended  
7 mm & 9 mm

**09-160-200**  
20.0 cm  
Double ended  
9.1 mm & 11.1 mm



**VOLKMAN**  
**09-161-150**  
15.0 cm



**VOLKMAN**  
**09-162-200**  
20.0 cm

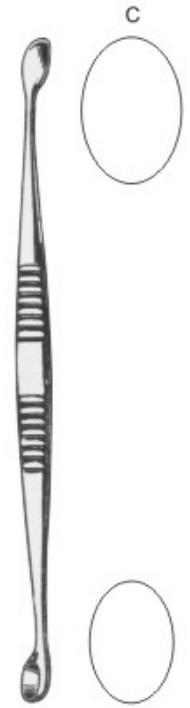

**VOLKMAN**  
**09-163-250**  
25.0 cm



**MARTINI**  
**09-164-140**  
14.0 cm



**JANSEN**  
**09-165-160**  
16.0 cm



**JANSEN**  
**09-166-150**  
15.0 cm



**09-167-160**  
16.0 cm



**KARPEL**  
**09-168-150**  
15.0 cm

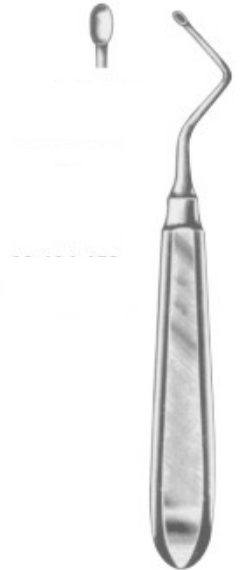

**KARPEL**  
**09-169-150**  
15.0 cm

**Orthopaedics**

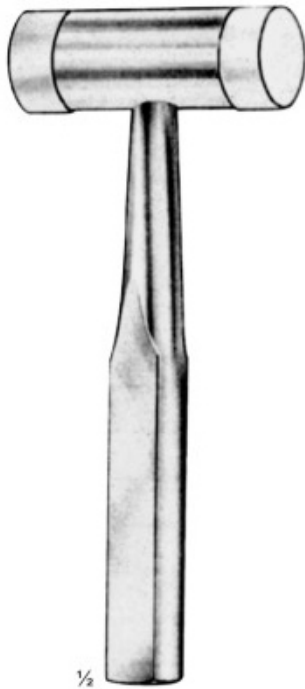

1/2  
**ORTHO / WITH PLASTIC CAPS**  
**09-170-180**  
18.0 cm  
25 mm Dia,  
5OZ (140g)



1/3  
**HAJEK**  
**09-171-223**  
22.25 cm  
27 mm Dia,  
5OZ (140g)



1/3  
**BERGMANN**  
**09-172-240**  
24.0 cm  
27 mm Dia,  
10 1/4OZ (300g)



1/2  
**COTTLE**  
**09-173-190**  
19.0 cm  
8 1/2OZ (240g)



1/3  
**COLLIN**  
**09-174-230**  
23.0 cm  
33 mm Dia,  
7 3/4OZ (220g)



1/2  
**WILLIGER**  
**09-175-155**  
15.5 cm

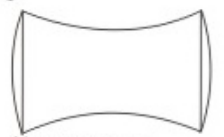







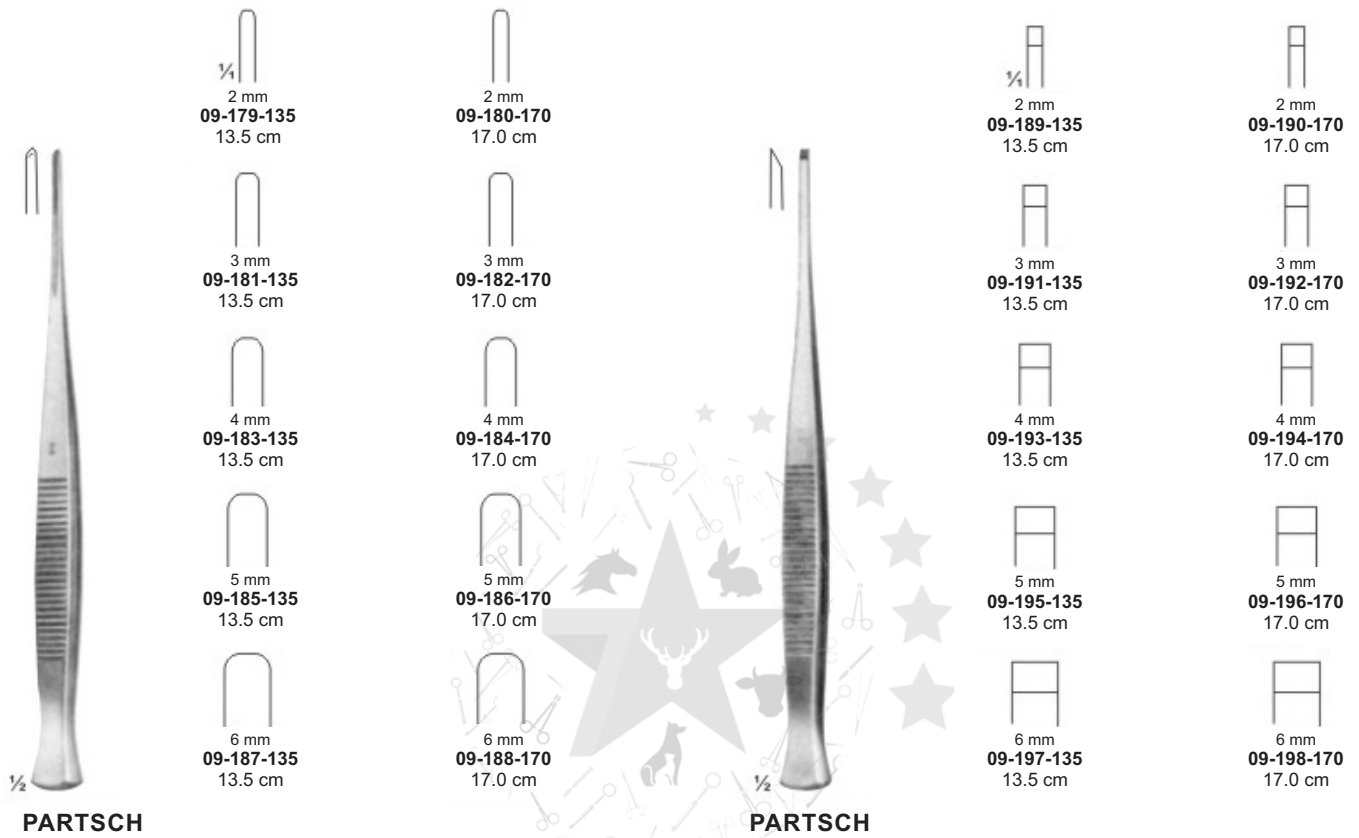













1/4  
**09-176-155**  
Head 26 mm Ø  
Weight 300 Gr.  
**09-177-155**  
Head 28 mm Ø  
Weight 340 Gr.  
**09-178-155**  
Head 30 mm Ø  
Weight 400 Gr.

**7 STELLA**  
Veterinary Surgical Instruments

**Orthopaedics**









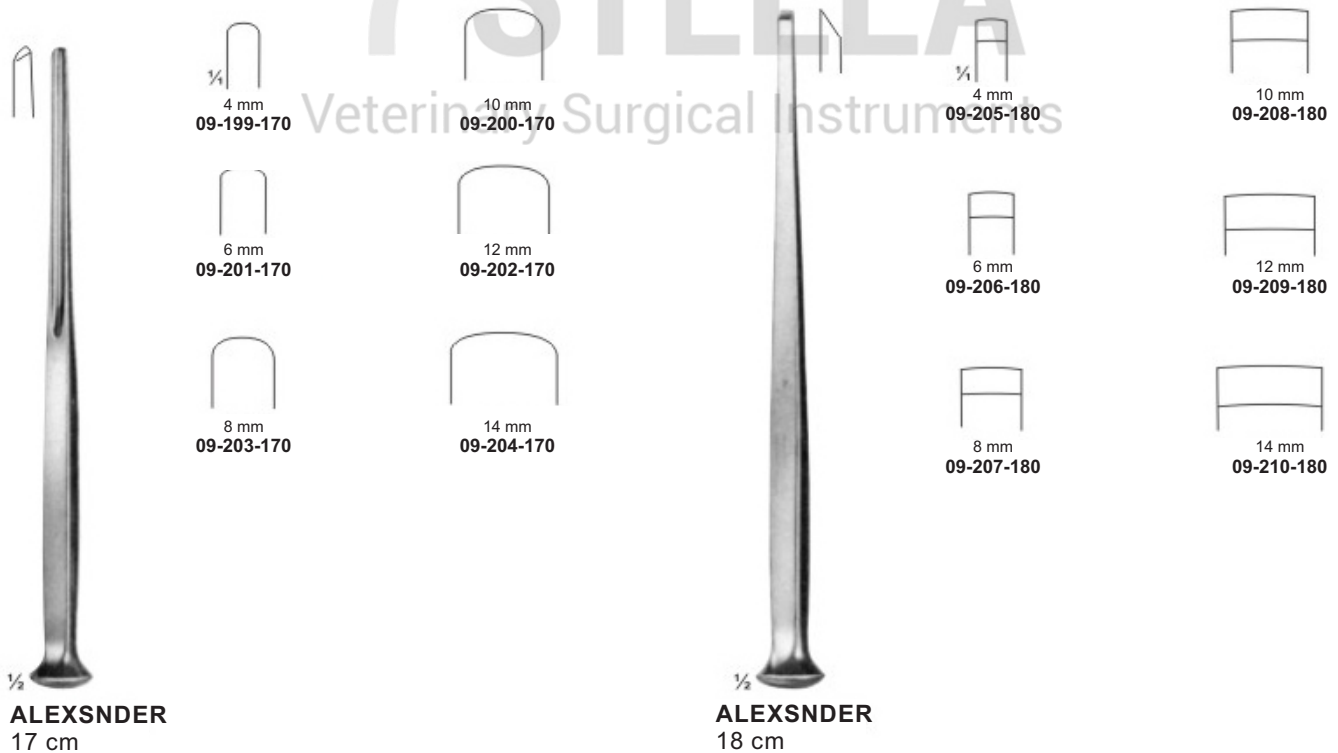





**PARTSCH**

	2 mm 09-179-135 13.5 cm		2 mm 09-180-170 17.0 cm		2 mm 09-189-135 13.5 cm		2 mm 09-190-170 17.0 cm
	3 mm 09-181-135 13.5 cm		3 mm 09-182-170 17.0 cm		3 mm 09-191-135 13.5 cm		3 mm 09-192-170 17.0 cm
	4 mm 09-183-135 13.5 cm		4 mm 09-184-170 17.0 cm		4 mm 09-193-135 13.5 cm		4 mm 09-194-170 17.0 cm
	5 mm 09-185-135 13.5 cm		5 mm 09-186-170 17.0 cm		5 mm 09-195-135 13.5 cm		5 mm 09-196-170 17.0 cm
	6 mm 09-187-135 13.5 cm		6 mm 09-188-170 17.0 cm		6 mm 09-197-135 13.5 cm		6 mm 09-198-170 17.0 cm

**7 STELLA**  
Veterinary Surgical Instruments



**ALEXSNDER**

	4 mm 09-199-170		10 mm 09-200-170		4 mm 09-205-180		10 mm 09-208-180
	6 mm 09-201-170		12 mm 09-202-170		6 mm 09-206-180		12 mm 09-209-180
	8 mm 09-203-170		14 mm 09-204-170		8 mm 09-207-180		14 mm 09-210-180

**ALEXSNDER**  
17 cm

**ALEXSNDER**  
18 cm

# Orthopaedics



**MINI-LAMBOTTE**  
12.5 cm

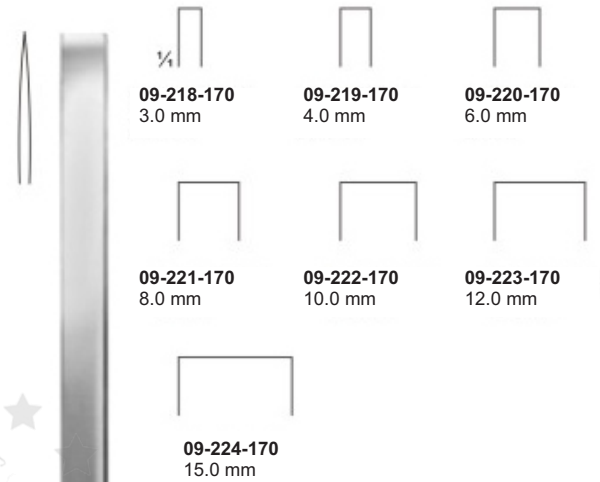
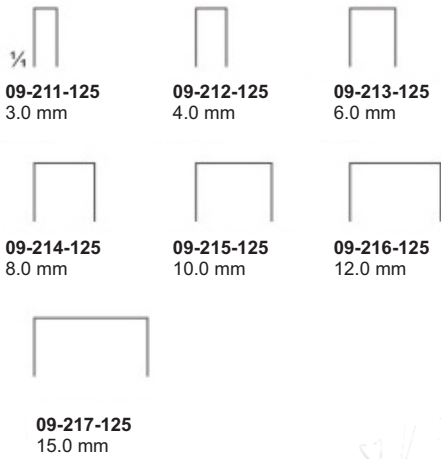

**MINI-LAMBOTTE**  
17.0 cm



**LAMBOTTE**  
24.0 cm

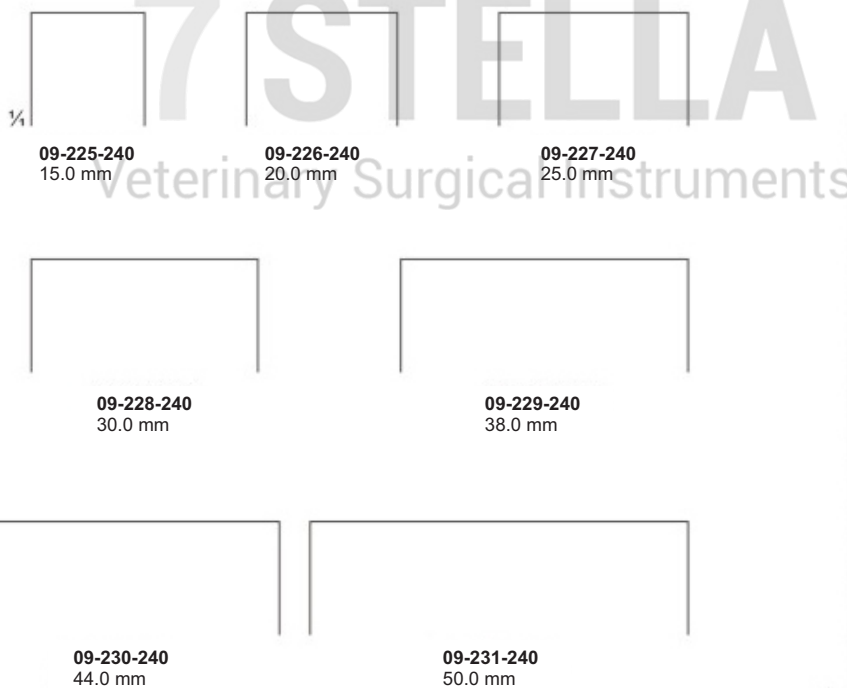

**LAMBOTTE**  
23.0 cm

- 09-232-230 15.0 mm
- 09-233-230 20.0 mm
- 09-234-230 25.0 mm
- 09-235-230 30.0 mm
- 09-236-230 38.0 mm
- 09-237-230 44.0 mm
- 09-238-230 50.0 mm

**Orthopaedics**



**LEXER FLAT**  
 09-239-220 1.0 cm  
 09-240-220 1.5 cm  
 09-241-220 2.0 cm  
 09-242-220 2.5 cm  
 22 cm Tip size



**LEXER HOLLOW**  
 09-243-220 1.0 cm  
 09-244-220 1.5 cm  
 09-245-220 2.0 cm  
 09-246-220 2.5 cm  
 22 cm Tip size



**MINI LEXER**  
 09-247-180  
 18.0 cm



**MINI LEXER**  
 09-248-180  
 18.0 cm  
 Hollow



**LEXER** Straight  
 09-249-250 0.5 cm  
 09-250-250 1.0 cm  
 09-251-250 1.5 cm  
 25 cm Tip size



**LEXER** Curved  
 09-252-250 0.5 cm  
 09-253-250 1.0 cm  
 09-254-250 1.5 cm  
 25 cm Tip size



**ZIELKE**  
 09-255-250 5.0 mm  
 09-256-250 10.0 mm  
 09-257-250 15.0 mm  
 gebogen/Curved  
 25 cm



**ZIELKE**  
 09-258-250 5.5 mm  
 09-259-250 9.0 mm  
 23 cm

**7 STELLA**  
 Veterinary Surgical Instruments

# Orthopaedics



- 09-260-200** Straight 0.6 cm
- 09-261-200** Straight 0.9 cm
- 09-262-200** Straight 1.2 cm
- 09-263-200** Straight 1.5 cm
- 09-264-200** Straight 2.0 cm
- 09-265-200** Straight 2.5 cm
- 09-266-200** Straight 3.0 cm
  
- 09-267-200** Curved 0.6 cm
- 09-268-200** Curved 0.9 cm
- 09-269-200** Curved 1.2 cm
- 09-270-200** Curved 1.5 cm
- 09-271-200** Curved 2.0 cm
- 09-272-200** Curved 2.5 cm
- 09-273-200** Curved 3.0 cm

**SMITH PETERSON**  
20.0 cm



- 09-274-200** 0.6 cm
- 09-275-200** 0.9 cm
- 09-276-200** 1.2 cm
- 09-277-200** 1.5 cm
- 09-278-200** 2.0 cm
- 09-279-200** 2.5 cm
- 09-280-200** 3.0 cm

**SMITH PETERSON**  
20.0 cm



- 09-281-200** Straight 1.0 cm
- 09-282-200** Straight 1.2 cm
- 09-283-200** Straight 1.5 cm
- 09-284-200** Straight 2.0 cm
- 09-285-200** Straight 2.5 cm
  
- 09-286-200** Curved 1.0 cm
- 09-287-200** Curved 1.2 cm
- 09-288-200** Curved 1.5 cm
- 09-289-200** Curved 2.0 cm
- 09-290-200** Curved 2.5 cm

**STILLE**  
20.0 cm



**STILLE**  
20.0 cm

- CHISELS**
- 09-291-200** 1.0 cm
  - 09-292-200** 1.2 cm
  - 09-293-200** 1.5 cm
  - 09-294-200** 2.0 cm
  - 09-295-200** 2.5 cm

- OSTEOTOME**
- 09-296-200** 1.0 cm
  - 09-297-200** 1.2 cm
  - 09-298-200** 1.5 cm
  - 09-299-200** 2.0 cm
  - 09-300-200** 2.5 cm



- WALTER**
- 09-301-200** 10 mm
  - 09-302-200** 15 mm
- 20.0 cm

**7 STELLA**  
Veterinary Surgical Instruments

# Orthopaedics



**REIL**  
09-303-170  
17.0 cm



**REDUCTION FORCEPS**  
09-304-200  
20.0 cm



**BONE HOLDING FORCEPS**  
09-305-170  
17.0 cm



**PLATE BONE HOLDING FORCEPS**  
09-306-130  
13.0 cm



**LEWIN**

09-307-175  
17.5 cm



**REPOSITION**  
09-308-130  
13.0 cm



**Orthopaedics**



**BONE HOLDING FORCEPS**  
09-309-135  
13.5 cm



**DINGMANN**  
09-310-180  
18.0 cm



**BONE HOLDING FORCEPS ( Spinlock )**  
09-311-160  
16.0 cm



**SETTER**  
09-312-220  
22.0 cm

**7 STELLA**  
Veterinary Surgical Instruments



**PATELLA**  
09-313-185  
18.5 cm



09-314-160 16.0 cm  
09-315-240 24.0 cm  
with thread lock

**Orthopaedics**



**REPOSITION  
FORCEPS**  
09-316-230  
23.0 cm



**HEY GROVES**  
09-317-210 21.0 cm  
09-318-270 27.0 cm  
09-319-300 30.0 cm



**LANE**  
09-320-330 33.0 cm  
09-321-470 47.0 cm

**7 STELLA**  
Veterinary Surgical Instruments



**LANE**  
09-322-330 33.0 cm  
09-323-470 47.0 cm



**KERN**  
09-324-160 16.0 cm with ratchet  
09-325-210 21.0 cm with ratchet  
09-326-160 16.0 cm without ratchet  
09-327-210 21.0 cm without ratchet



**FARABEUF-LAMBOTTE**  
09-328-230 23.0 cm with ratchet  
09-329-260 26.0 cm with ratchet  
09-330-230 23.0 cm mm without ratchet  
09-331-260 26.0 cm mm without ratchet

**Orthopaedics**



**SELF-CENTERING**

- 09-332-150**  
15.0 cm For small fragments, jaw 9 mm
- 09-333-190**  
19 cm, Extra small jaw 10 mm
- 09-334-240**  
24 cm, small jaw 14 mm
- 09-335-260**  
26 cm, medium jaw 18 mm
- 09-336-280**  
28 cm, large jaw 23 mm



- ULRICH**
- 09-337-190** 19.0 cm
  - 09-338-230** 23.0 cm
  - 09-339-250** 25.0 cm
  - 09-340-280** 28.0 cm



- LAMBOTTE**
- 09-341-220** 22.0 cm
  - 09-342-270** 27.0 cm
  - 09-343-330** 33.0 cm



**09-344-200**  
20.0 cm



**SEMB**  
**09-345-190**  
19.0 cm



**FERGUSON**  
**09-346-230**  
23.0 cm

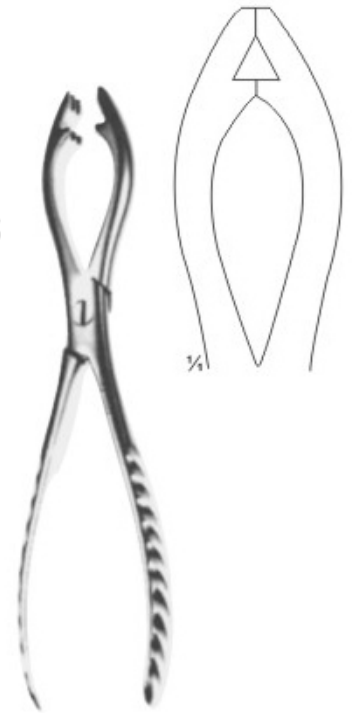

**FERGUSON**  
**09-347-210**  
21.0 cm

**Orthopaedics**



**VERBRUGGE**  
09-348-180  
18.0 cm



**VERBRUGGE**  
09-349-180  
18.0 cm



**VERBRUGGE**  
09-350-250 25.0 cm  
09-351-260 26.0 cm  
09-352-270 27.0 cm



**VERBRUGGE**  
09-353-250 25.0 cm  
09-354-260 26.0 cm  
09-355-270 27.0 cm



**VERBRUGGE**  
09-356-180  
18.0 cm

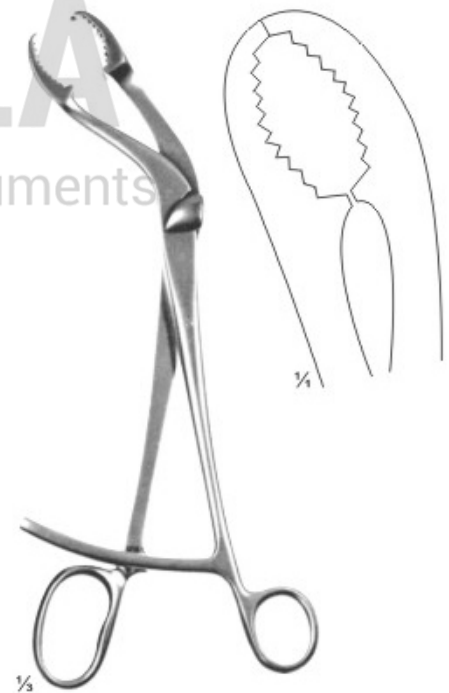

**VERBRUGGE**  
09-357-250 25.0 cm  
09-358-260 26.0 cm  
09-359-270 27.0 cm

**Orthopaedics**



**STELLBRINK  
SYNOVCTOMY**  
09-360-175  
17.5 cm

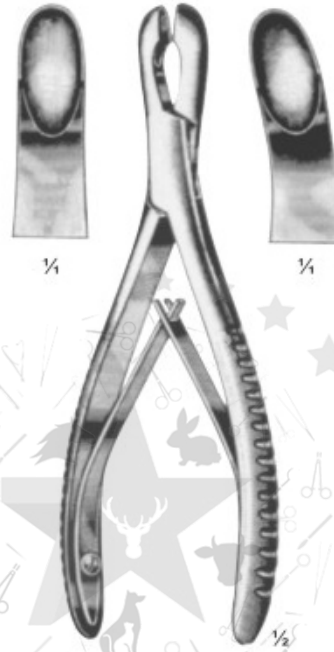

**LUER**  
09-361-170 17.0 cm Straight  
09-362-170 17.0 cm Curved



**LEMPERT**  
09-363-190 19.0 cm Straight  
09-364-190 19.0 cm Curved



**CLEVELAND**  
09-365-140 14.0 cm  
09-366-140 14.0 cm

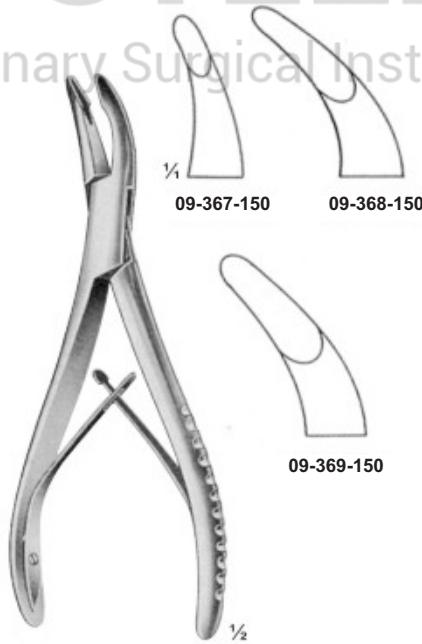

**LUER**  
15.0 cm

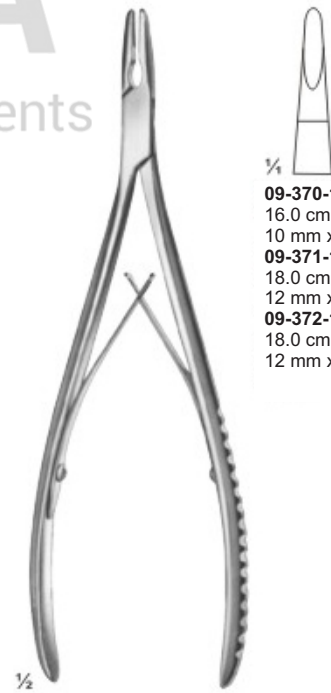

**LEMPERT**

09-370-160  
16.0 cm, Curved  
10 mm x 4.5 mm  
09-371-180  
18.0 cm, Straight  
12 mm x 3 mm  
09-372-180  
18.0 cm, Curved  
12 mm x 3 mm

**7 STELLA**  
Veterinary Surgical Instruments

**Orthopaedics**

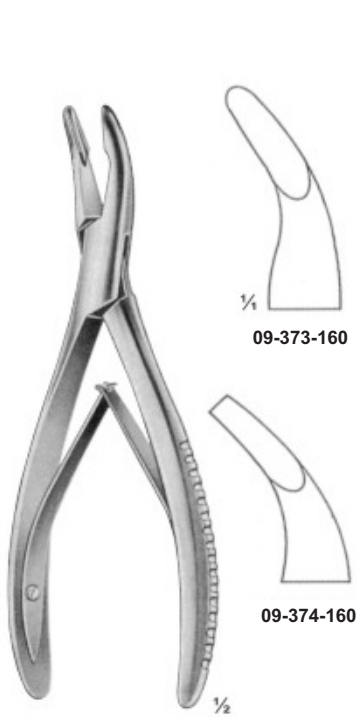

**MEAD**  
16.0 cm

09-373-160

09-374-160

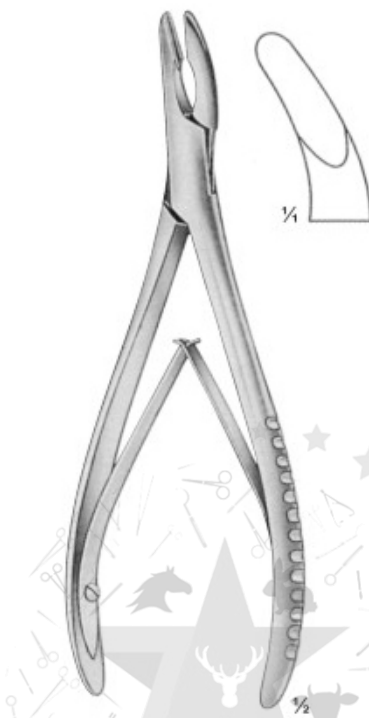

**MARTMANN**  
09-375-185  
18.5 cm

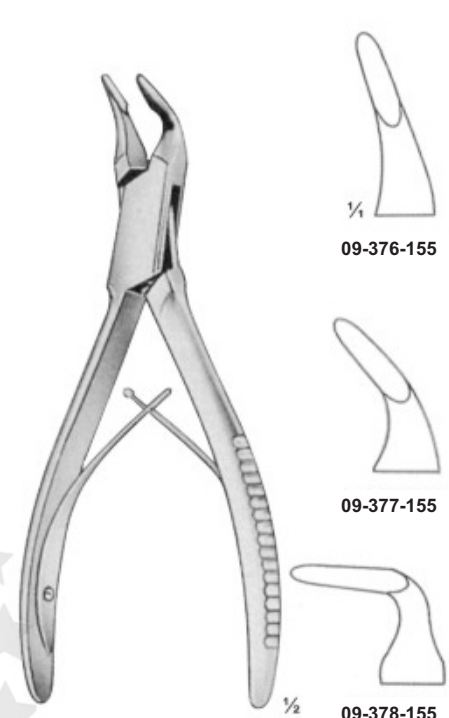

**BLUMENTHAL**  
15.5 cm

09-376-155

09-377-155

09-378-155



**FRIEDMAN & MINI-FRIEDMAN**

09-379-130  
13.0 cm, Curved  
13 mm x 2.5 mm

09-380-140  
14.0 cm, Curved  
12 mm x 3 mm



**UNIVERSAL**

09-381-133  
13.25 cm,  
Angled  
17 mm x 3.5 mm



**ADSON**  
09-382-20  
20.0 cm, Straight  
15 mm x 7.5 mm

**Orthopaedics**

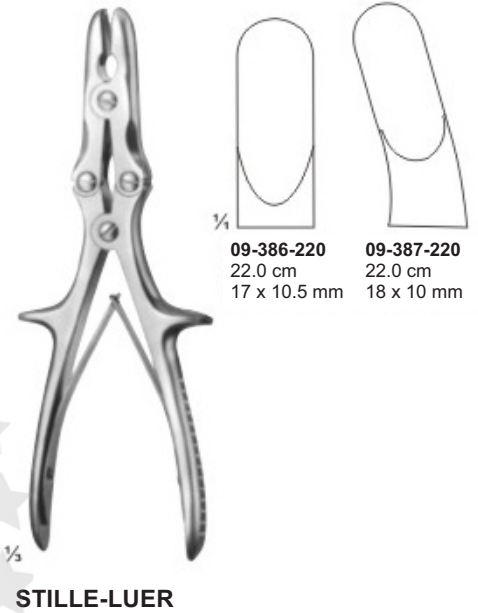
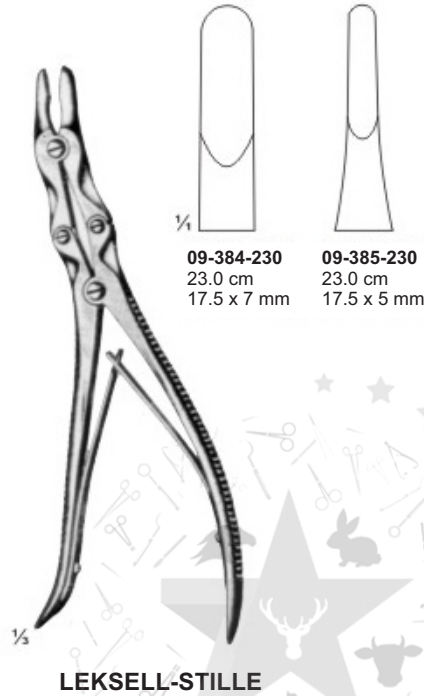

# Orthopaedics



**09-392-150**  
15.25 cm  
Curved  
18 x 5 mm

**RUSKIN-MINI**



**09-393-150**  
15.25 cm  
Straight  
5 x 15 mm

**BOHLER**

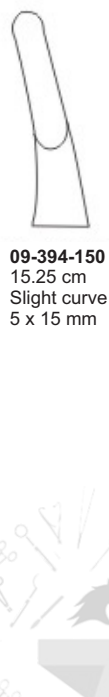

**09-394-150**  
15.25 cm  
Slight curve  
5 x 15 mm



**09-395-180**  
18.0 cm  
Slightly Curved  
16.5 x 5.5 mm

**RUSKIN**



**09-396-180**  
18.0 cm  
Curved  
18 x 3.5 mm

**BEYER**



**09-397-180**  
18.0 cm  
Slightly Curved  
18 x 4 mm

**ZAUFAL-JANSEN**

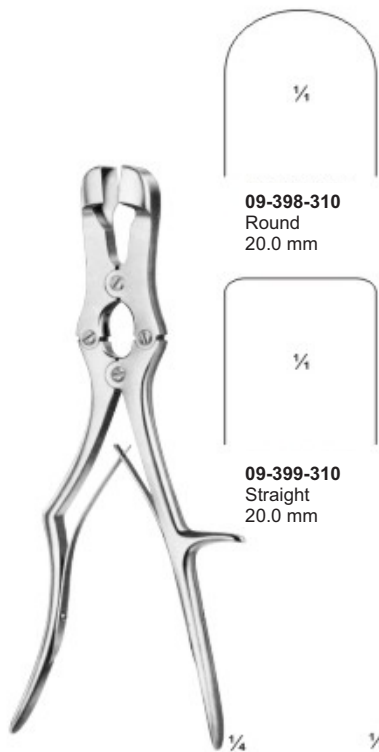

**09-398-310**  
Round  
20.0 mm

**SAUERBRUCH**  
31.0 cm



**09-399-310**  
Straight  
20.0 mm

**SEMB**

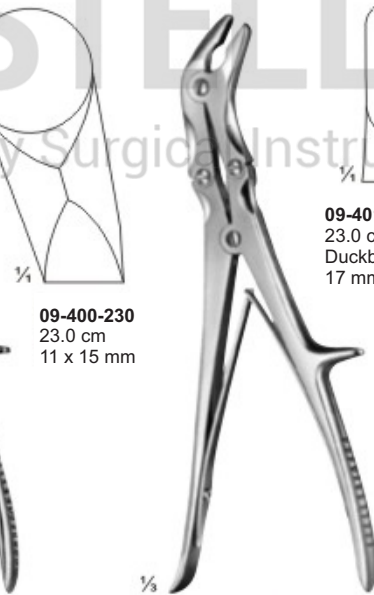

**09-401-230**  
23.0 cm  
Duckbill  
17 mm x 6 mm

**STILLE**



**09-402-230**  
23.0 cm  
Double-Action  
Fully Curved  
Jaw 7mm x 13mm wide  
3 mm, 5 mm, 8 mm

**LEKSELL**



**Orthopaedics**

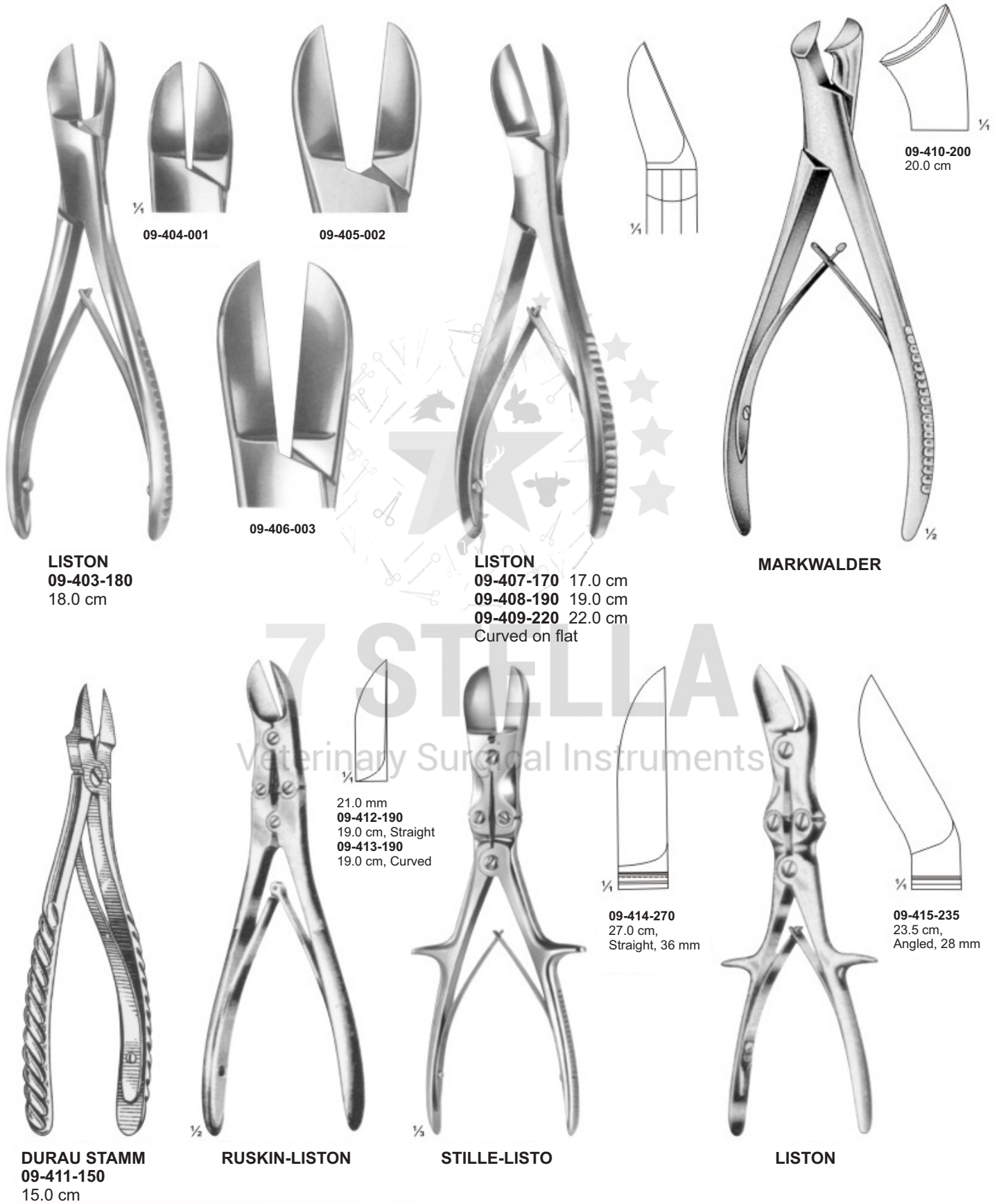

# Orthopaedics

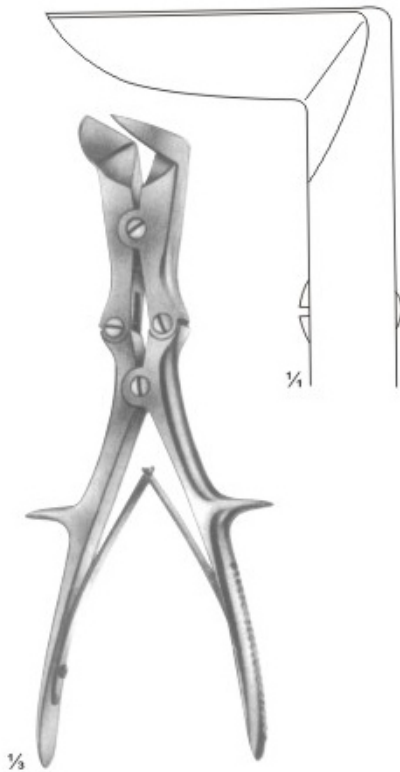

**LISTON-STILLE**  
09-416-260  
26.0 cm

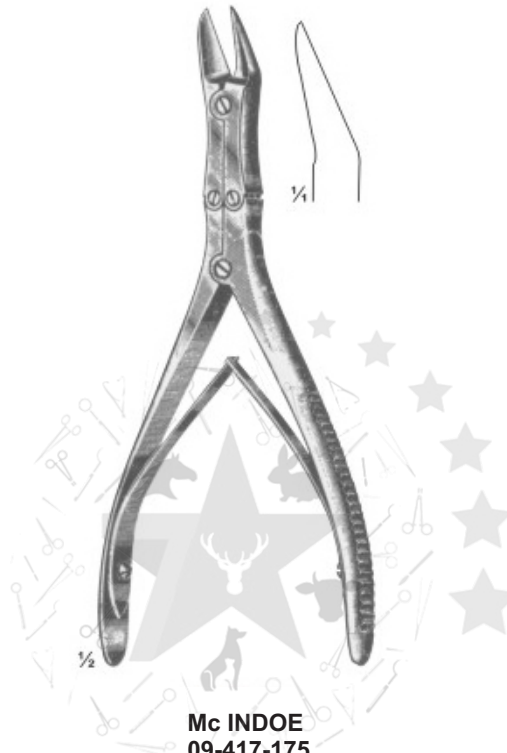

**Mc INDOE**  
09-417-175  
17.5 cm



**BOHLER**  
09-418-150 15.0 cm Straight  
09-419-150 15.0 cm Curved

**7 STELLA**  
Veterinary Surgical Instruments



**RUSKIN**  
09-420-200  
20.0 cm



**HORSLEY**  
09-421-250  
25.0 cm



**LISTON-KEY (HORSLEY)**  
09-422-270  
27.0 cm  
Angled, 28 mm

**Orthopaedics**



**09-423-160**  
16.0 cm



**09-424-150**  
15.0 cm



**PERTHES**  
**09-425-160** 16.0 cm  
**09-426-220** 22.0 cm



**KOCUER**  
**09-427-220**  
23.0 cm  
3 cm Dia.

Awls for wire suture



**ESMARCH**  
**09-428-200**  
with 2 drill point  
(09-321-200 + 09-322-200)  
20.0 cm

Bone Drills

**09-429-001** **09-430-002**



**OBWEGESER**  
**09-431-230**  
23.0 cm



**OBWEGESER**  
**09-432-195**  
19.5 cm



**BRUNNER**  
**09-433-300**  
30.0 cm

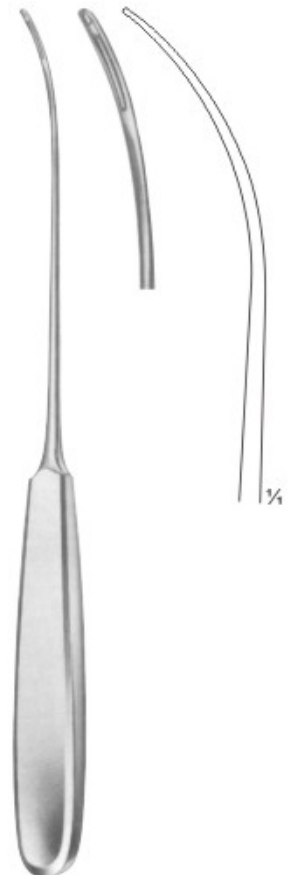

**MALLEABLE**  
**09-434-230**  
23.0 cm

**Orthopaedics**



**KIRSCHNER**  
09-435-00 40 x 140 mm  
09-436-00 60 x 220 mm



**KIRSCHNER, AMERICAN TYPE**  
09-437-130 Medium 13.0 cm  
09-438-185 Large 18.5 cm  
09-439-220 Extra Large 22.0 cm  
Max. Jaw Opening



**KIRSCHNER**  
09-440-00 200 x 155 mm  
09-441-00 155 x 155 mm  
09-442-00 135 x 130 mm  
09-443-00 120 x 120 mm  
09-444-00 105 x 100 mm  
09-445-00 95 x 110 mm  
09-445-00 95 x 70 mm

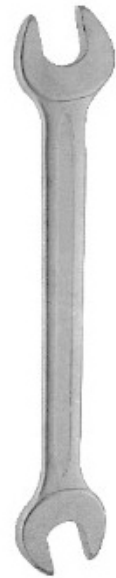

**SCREW NUT WRENCH**  
09-446-00  
14 x 17 mm

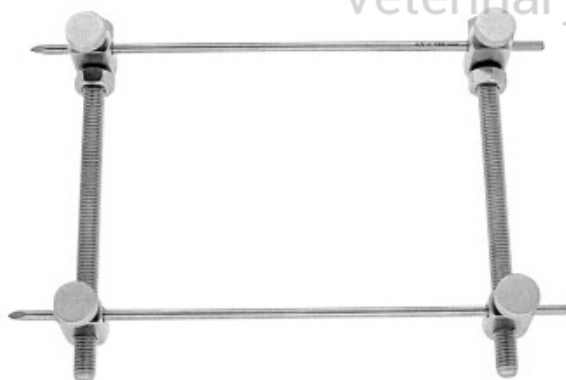

**CHARNLEY-MUELLER**  
09-447-00  
Compression clamp



	Inside Length	Inside Width
09-448-00	90 mm	75 mm
09-449-00	160 mm	90 mm
09-450-00	210 mm	110 mm
09-451-00	210 mm	150 mm



**WIRE TIGHTENING**  
09-452-180  
18.0 cm

**Orthopaedics**



**WIRE HOLDING**  
09-553-200 20.0 cm  
09-554-250 25.0 cm



**WIRE HOLDING**  
09-455-180 18.0 cm  
with Serrated jaws



**WIRE BENDING CUTTING**  
09-456-100 10.0 cm



**WIRE BENDING PLIERS**  
09-457-100 10.0 cm

**7 STELLA**  
Veterinary Surgical Instruments



**WIRE HOLDING**

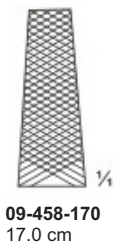

**WIRE HOLDING**



**EXTRACTION PLIERS**  
09-461-130 13.0 cm  
09-462-180 18.0 cm

# Orthopaedics



**WIRE HOLDING**  
09-463-180 18.0 cm



**LOCKING PLIERS**  
09-464-150  
15.0 cm  
With spring  
Serrated



**WIRE HOLDING**  
09-465-180 18.0 cm



**SLIP JOINT**  
09-466-195  
19.5 cm



**7 STELLA**  
Veterinary Surgical Instruments

**Orthopaedics**



**09-467-150**  
15.0 cm



**DIAMANT PIN CUTTER**  
**09-468-160**  
16.0 cm

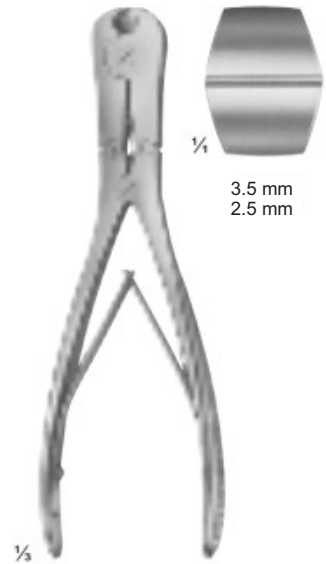

**09-469-220**  
22.0 cm



**09-470-320**  
32.0 cm  
3.0 mm

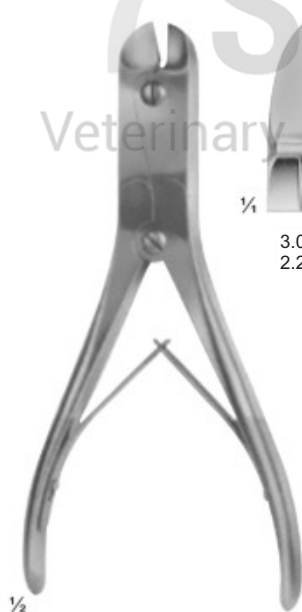

**09-471-235**  
23.5 cm



**09-472-140**  
14.0 cm  
1.2 mm

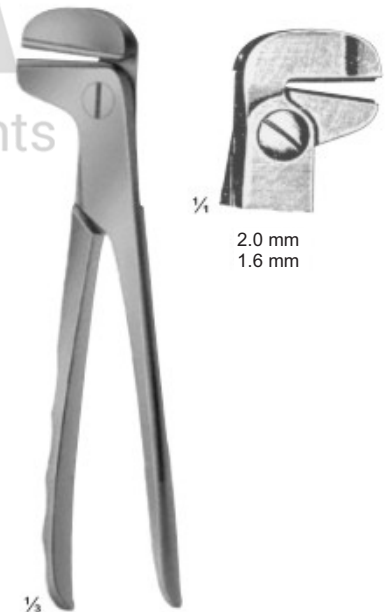

**09-473-240**  
24.0 cm

**7 STELLA**  
Veterinary Surgical Instruments

**Orthopaedics**



**GIGLI SAW**  
09-474-030 30.0 mm  
09-475-040 40.0 mm  
09-476-050 50.0 mm  
09-477-070 70.0 mm  
stainless



**GIGLI HANDLE**  
09-478-00



**ENGEL  
PLASTER SAW**  
09-479-155  
15.5 cm



**CHARRIERE**  
09-480-250 25.0 cm  
09-481-270 27.0 cm  
Double saw



**CHARRIERE**  
09-482-270 27.0 cm  
09-483-300 30.0 cm



**CHARRIERE**  
09-484-350  
35.0 cm



**SATTERLEE**  
09-485-310  
31.0 cm

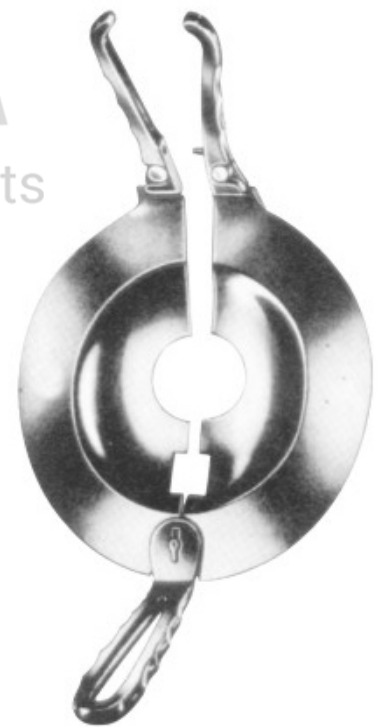

**PERCY RETRACTOR**  
09-486-00



# Orthopaedics



**KEY**  
With fiber  
**09-487-180**  
Handle 18.0 cm



**SCREW DRIVER**  
**09-488-00**  
slotted head



**SCREW DRIVER**  
**09-489-00**  
Philips head



**SCREW DRIVER**  
**09-490-00**  
Single head



**BONE SCREW  
HOLDING FORCEPS**  
**09-491-00**  
Bone screw



**BONE PLATE  
HOLDING FORCEPS**  
**09-492-00**  
Bone Plate

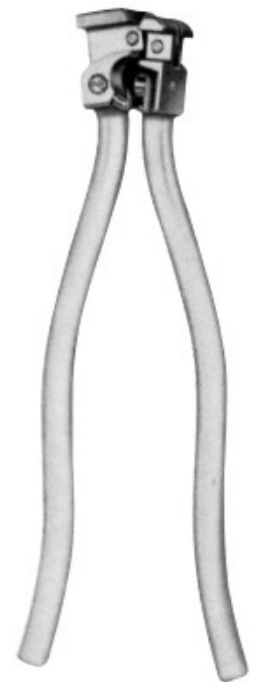

**BENDING PLIERS**  
**09-493-00**  
2.7 mm & 3.5 mm  
Plate

# T.C. Flat Nose Pliers & Wire Cutting Pliers



**EXTRACTION PLIERS**  
09-494-180  
18.0 cm



**EXTRACTION PLIERS**  
09-495-200  
20.0 cm



**EXTRACTION PLIERS**  
09-496-200  
20.0 cm



**EXTRACTION PLIERS**



**WIRE CUTTERS**  
09-499-180  
18.0 cm



**WIRE CUTTERS**  
09-500-180 18.0 cm  
09-501-210 21.0 cm



**WIRE CUTTERS**  
09-502-180  
18.0 cm

**7 STELLA**  
Veterinary Surgical Instruments

# T.C. Wire Cutting Pliers



**UNIVERSAL SCISSORS**  
09-503-100 10.0 cm  
09-504-120 12.0 cm



**WIRE CUTTER**  
09-505-180  
18.0 cm



**WIRE CUTTERS**  
09-506-180  
18.0 cm

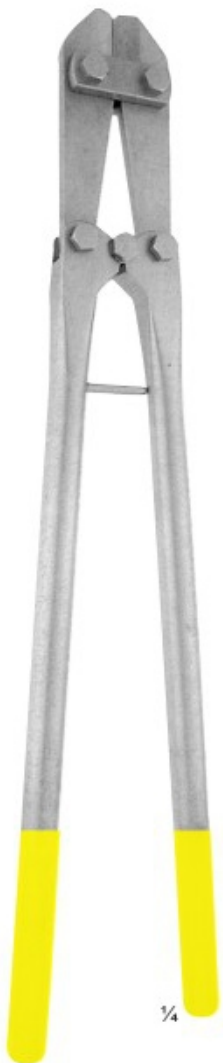

**WIRE CUTTERS**  
09-507-460 46.0 cm  
09-508-560 56.0 cm



**WIRE CUTTERS**  
09-509-180 18.0 cm  
09-510-220 22.0 cm

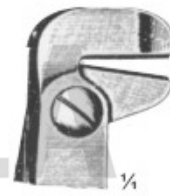

2.0 mm  
1.6 mm



**09-511-240**  
24.0 cm