

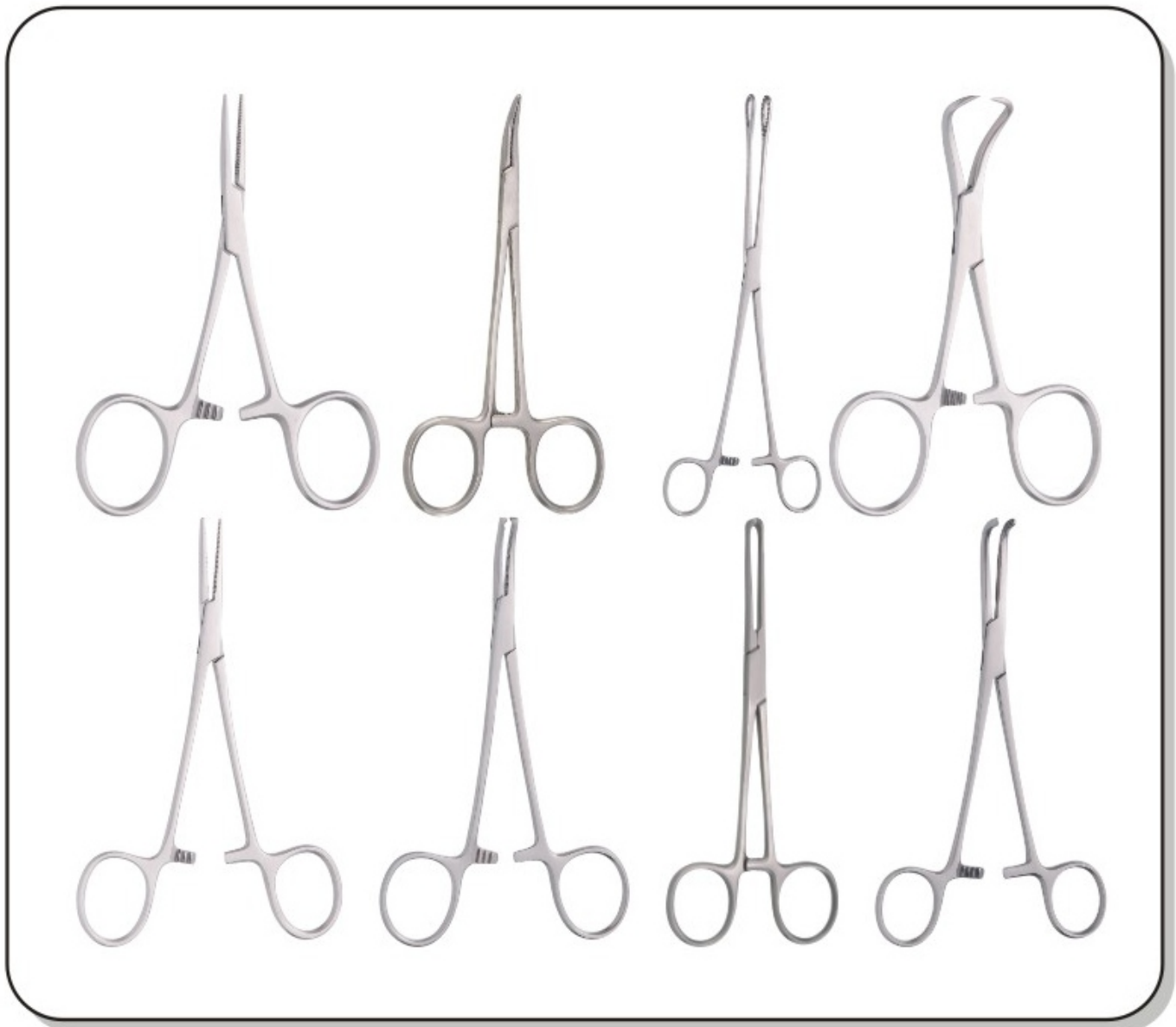

Haemostatic Forceps

SECTION - 04

HAEMOSTATIC FORCEPS



Haemostatic Forceps



04-001-100 10.0 cm
Straight, Serrated

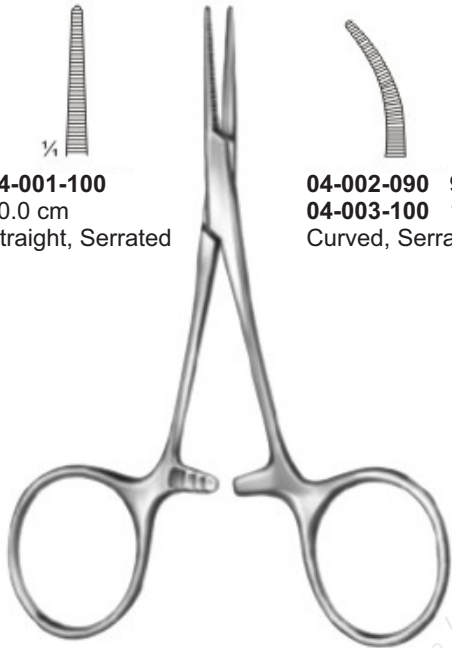

HARTMANN / MOSQUITO



04-002-090 9.0 cm
04-003-100 10.0 cm
Curved, Serrated



KOCHER MOSQUITO 1:2



04-004-100 10.0 cm
04-005-120 12.0 cm
Straight



04-006-100 10.0 cm
04-007-120 12.0 cm
Curved



HALSTED-MOSQUITO



04-008-125 12.5 cm
04-009-140 14.0 cm
Straight, Serrates



04-010-125 18.0 cm
Straight, Serrates



04-011-210 21.0 cm
Straight, Serrates



04-012-125 12.5 cm
04-013-140 14.0 cm
Curved, serrated



04-114-180 18.0 cm
Curved, serrated



04-115-205 5 cm
Curved, serrated



04-016-125 12.5 cm
04-017-140 14.0 cm
Straight, 1:2 Teeth



04-018-180 18.0 cm
Straight, 1:2 Teeth

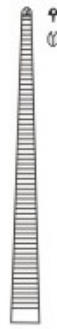

04-019-210 21.0 cm
Straight, 1:2 Teeth



04-020-125 12.5 cm
04-021-140 14.0 cm
Curved, 1:2 Teeth



04-022-180 18.0 cm
Curved, 1:2 Teeth



04-023-180 20.5 cm
Curved, 1:2 Teeth

Haemostatic Forceps

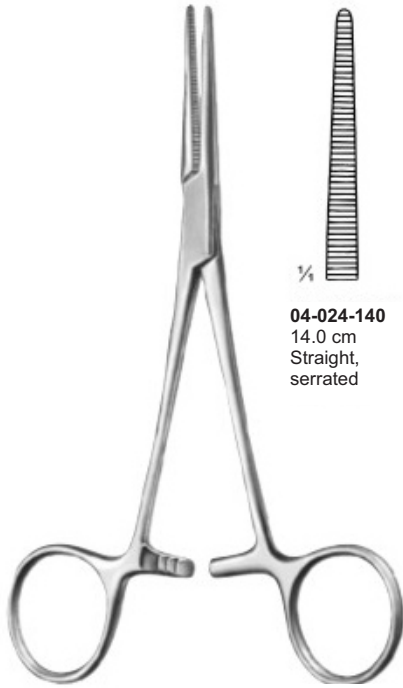

CRILE

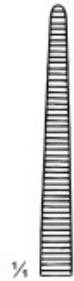

04-024-140
14.0 cm
Straight,
serrated



04-025-140
14.0 cm
Curved,
serrated



04-026-140
14.0 cm
Straight,
1:2 Teeth



04-027-140
14.0 cm
Curved,
1:2 Teeth



CRILE-RANKIN



04-028-160
16.0 cm
Straight,
serrated



04-029-160
16.0 cm
Curved,
serrated

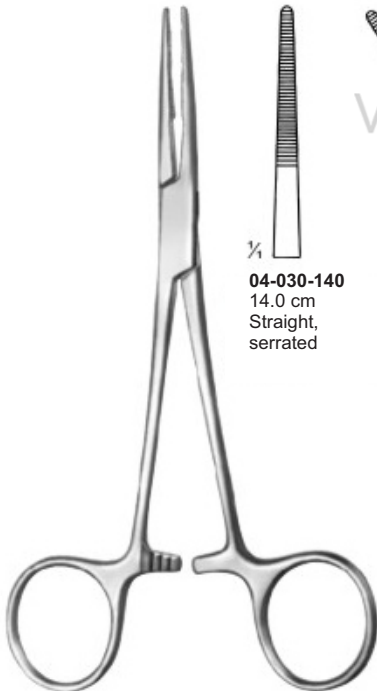

KELLY



04-030-140
14.0 cm
Straight,
serrated



04-031-140
14.0 cm
Curved,
serrated

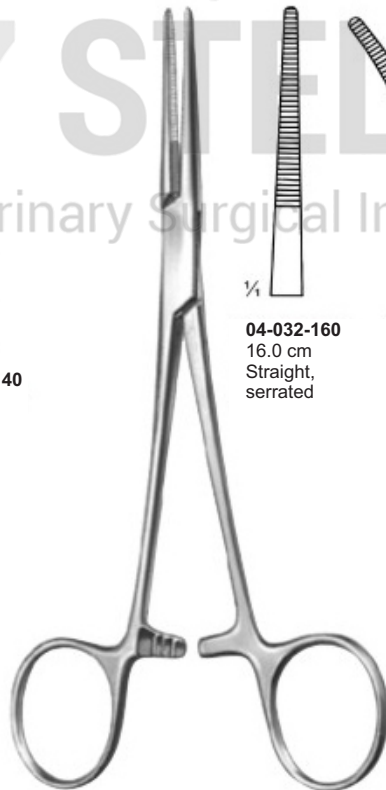

KELLY-RANKIN



04-032-160
16.0 cm
Straight,
serrated



04-033-160
16.0 cm
Curved,
serrated

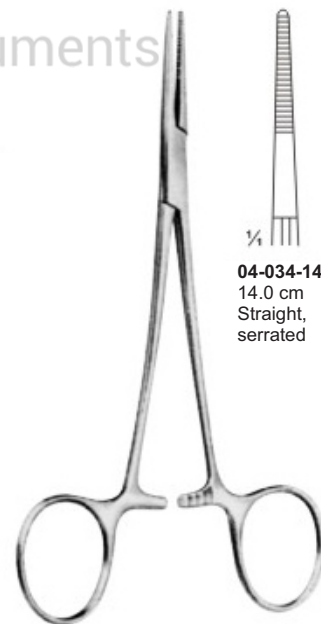

PROVIDENCE/HOSPITAL



04-034-140
14.0 cm
Straight,
serrated



04-035-140
14.0 cm
Curved,
serrated

Haemostatic Forceps



SPENCER-WELLS



04-036-130
13.0 cm



04-037-140
14.0 cm



04-038-155
15.5 cm



04-039-180
18.0 cm



04-040-200
20.0 cm



04-041-130
13.0 cm



04-042-140
14.0 cm



04-043-155
15.5 cm



04-044-180
18.0 cm



04-045-200
20.0 cm

7 STELLA
Veterinary Surgical Instruments



DUNHILL
04-046-130 13.0 cm
Straight, box joint,
as above but Curved on
flat.

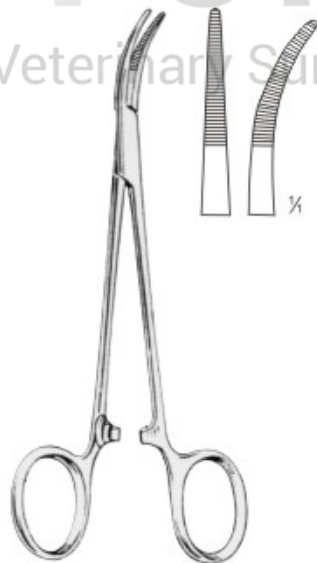

CAIRNS
04-047-145 14.5 cm
Straight, box joint,
as above but Curved on
flat.

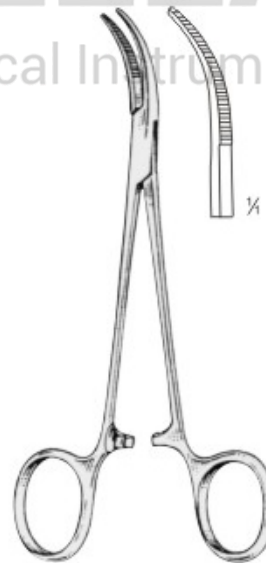

CAIRNS
04-048-145 14.5 cm
Curved laterally, joint.

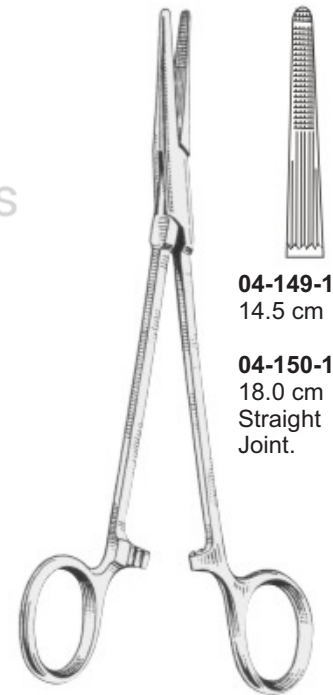

GREY TURNER

04-149-145
14.5 cm

04-150-180
18.0 cm
Straight
Joint.

Haemostatic Forceps



CRAFOORD-SELLORS

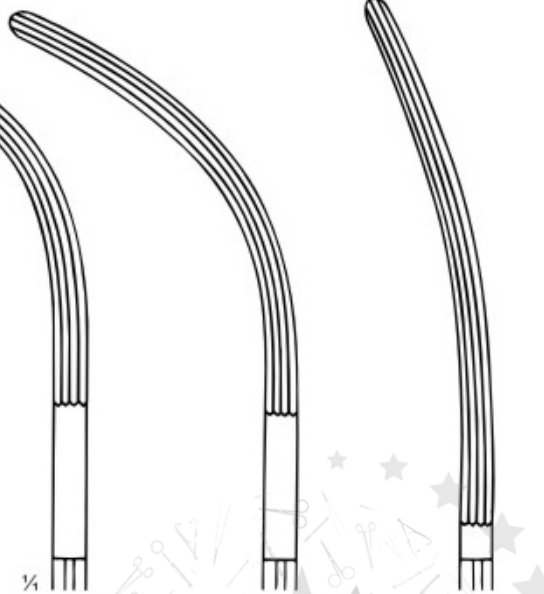

04-051-220
22.0 cm

04-052-230
23.0 cm

04-053-240
24.0 cm



ROBERTS

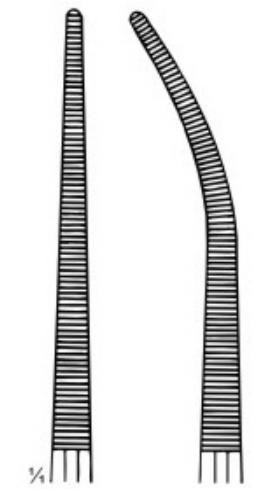

04-054-220
22.0 cm

04-055-220
22.0 cm

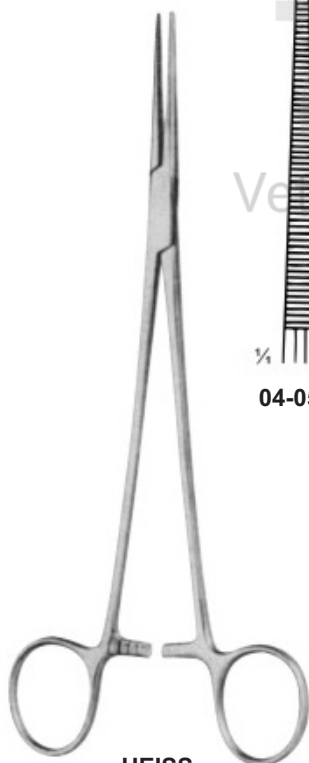

HEISS
20.0 cm

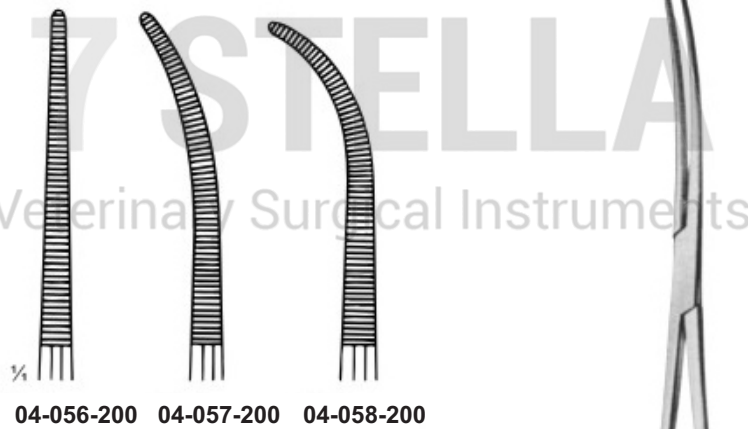

04-056-200

04-057-200

04-058-200



CRAFOORD

04-059-240
24.0 cm

Haemostatic Forceps

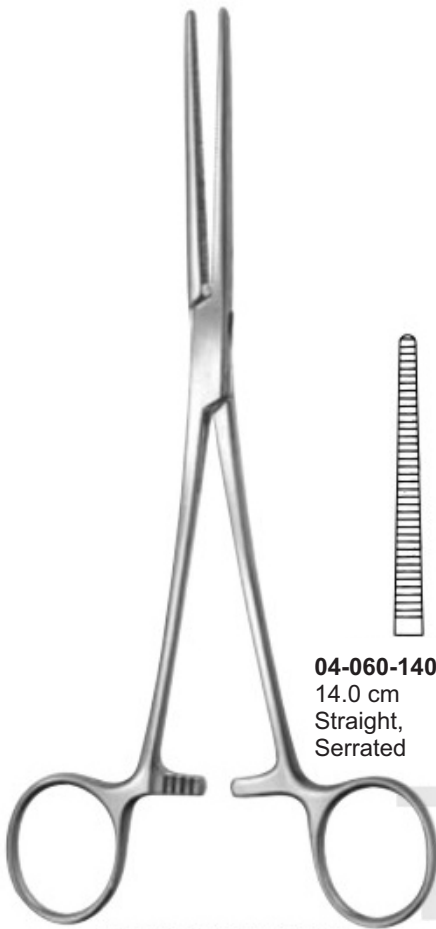

ROCHESTER / PEAN

04-060-140
14.0 cm
Straight,
Serrated

04-061-160
16.0 cm
Straight,
Serrated

04-062-180
18.0 cm
Straight,
Serrated

04-063-200
20.0 cm
Straight,
Serrated

04-064-220
22.0 cm
Straight,
Serrated

04-065-240
24.0 cm
Straight,
Serrated

04-066-260
26.0 cm
Straight,
Serrated

04-067-300
30.0 cm
Straight,
Serrated

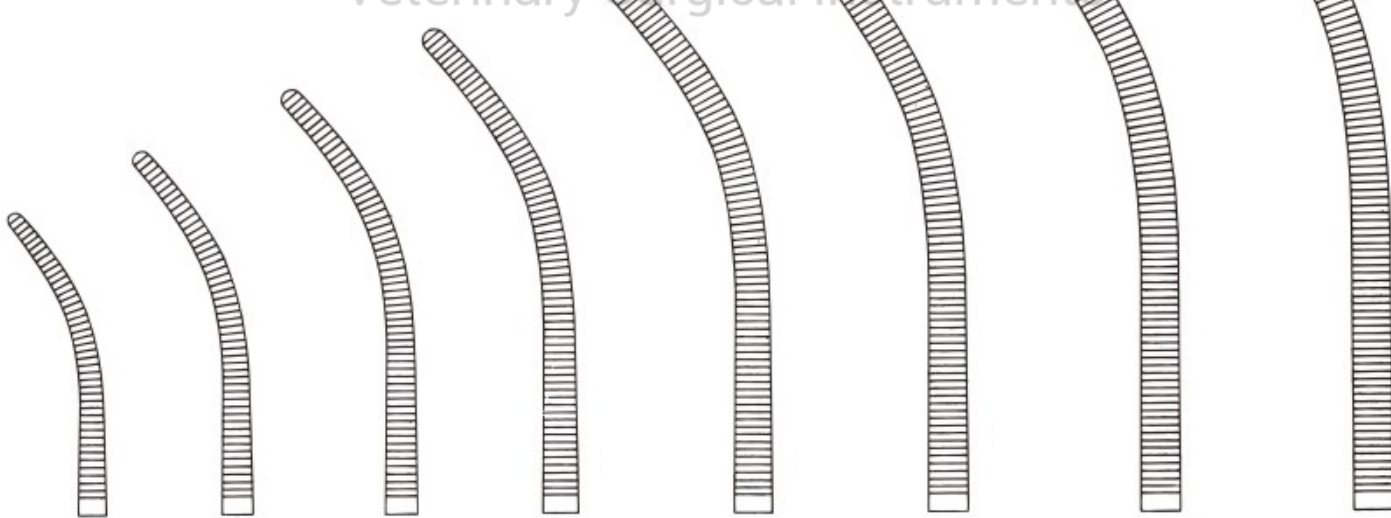
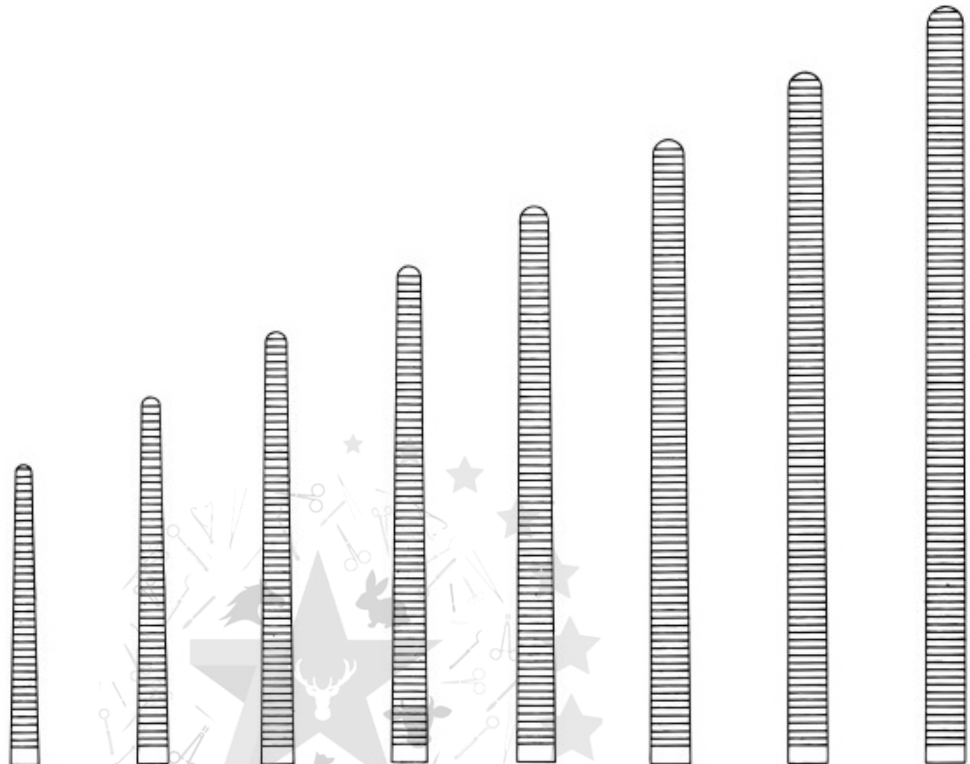

04-068-140
14.0 cm
Curved,
Serrated

04-069-160
16.0 cm
Curved,
Serrated

04-070-180
18.0 cm
Curved,
Serrated

04-071-200
20.0 cm
Curved,
Serrated

04-072-220
22.0 cm
Curved,
Serrated

04-073-240
24.0 cm
Curved,
Serrated

04-074-260
26.0 cm
Curved,
Serrated

04-075-300
30.0 cm
Curved,
Serrated

Haemostatic Forceps



KOCHER / DELICATE



04-076-130 13.0 cm
04-077-140 14.0 cm
04-078-160 16.0 cm
Straight, 1:2 Teeth



04-079-140 14.0 cm
Curved, 1:2 Teeth

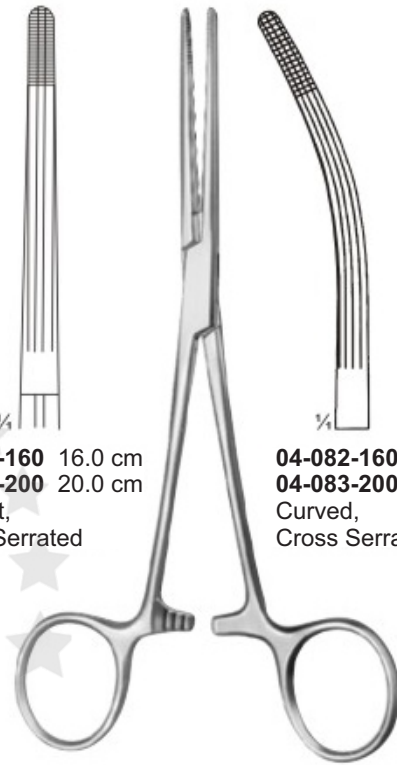

ROCHESTER / CARMALT



04-080-160 16.0 cm
04-081-200 20.0 cm
Straight, Cross Serrated



04-082-160 16.0 cm
04-083-200 20.0 cm
Curved, Cross Serrated

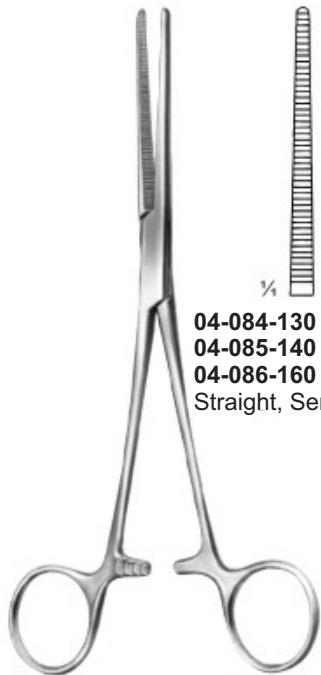

PEAN-DELICATE



04-084-130 13.0 cm
04-085-140 14.0 cm
04-086-160 16.0 cm
Straight, Serrated



04-087-130 13.0 cm
04-088-140 14.0 cm
04-089-160 16.0 cm
Curved, Serrated

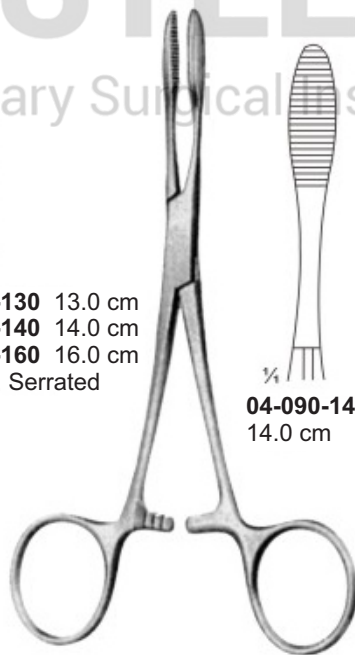

PEAN



04-090-140 14.0 cm
04-091-160 16.0 cm



04-091-160 16.0 cm

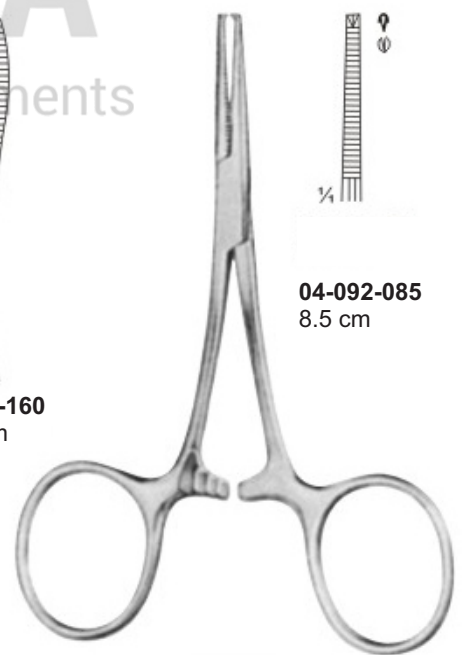

TERRIER 1:2



04-092-085 8.5 cm

7 STELLA
Veterinary Surgical Instruments

Haemostatic Forceps

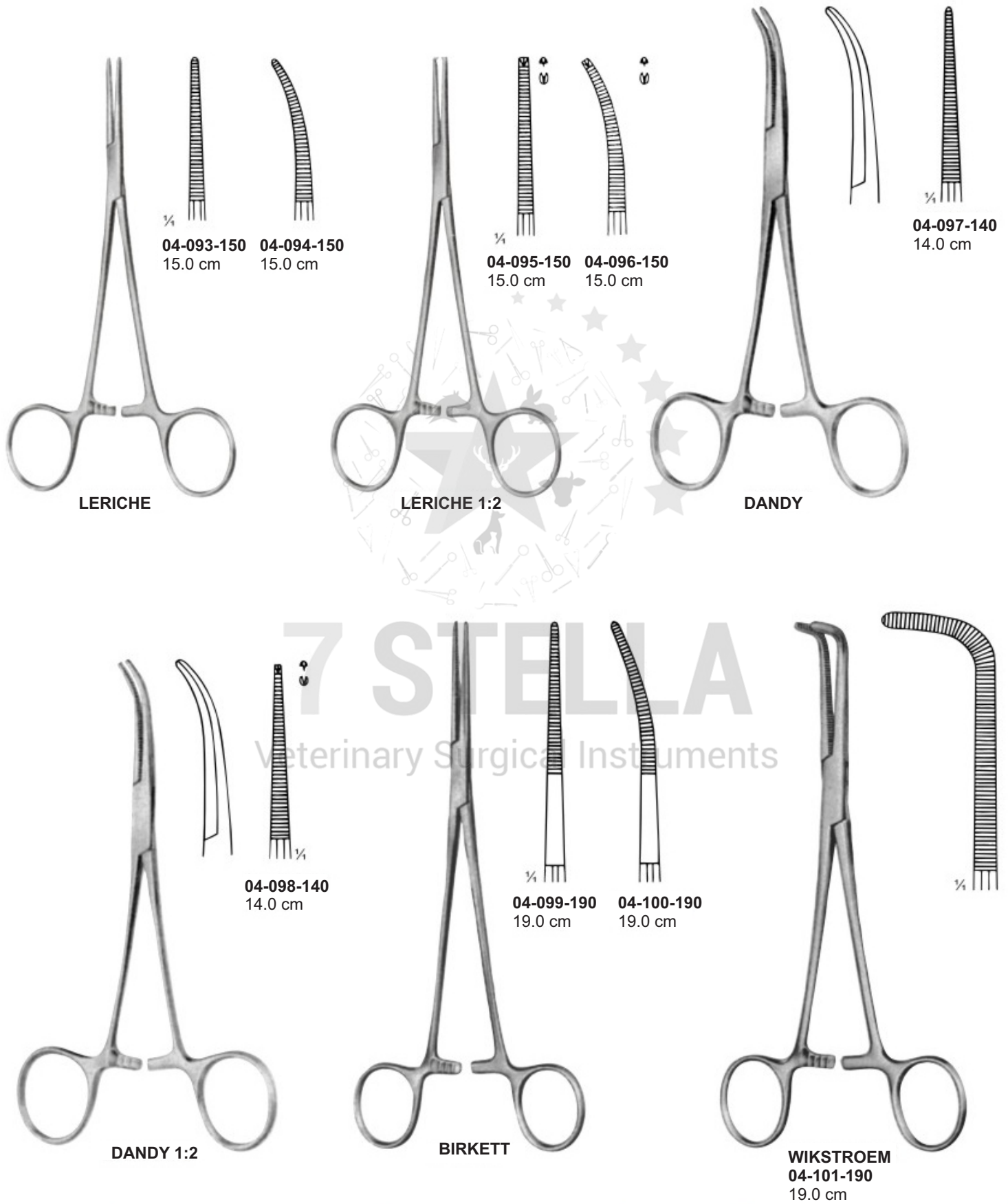

Haemostatic Forceps



BABY-ADSON

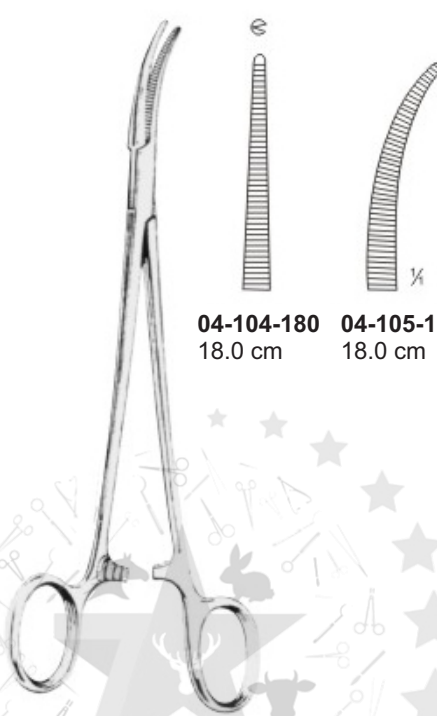
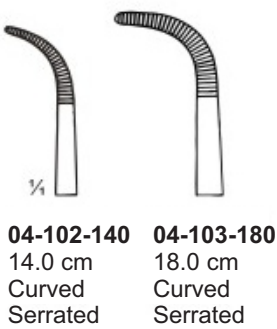

ADSON
Straight, box joint,
as above but Curved flat.
Straight, box joint,
one into two teeth

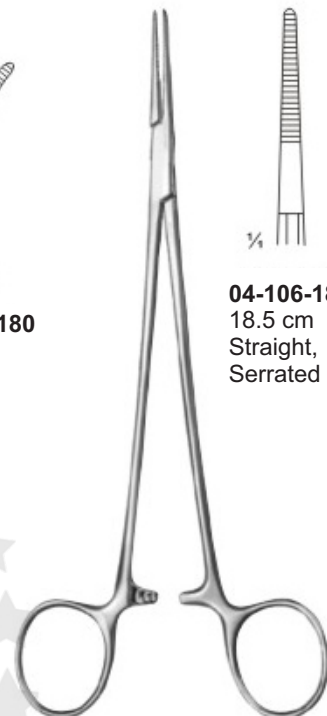
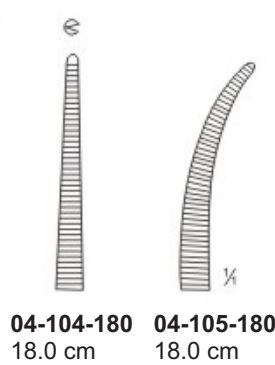

ADSON

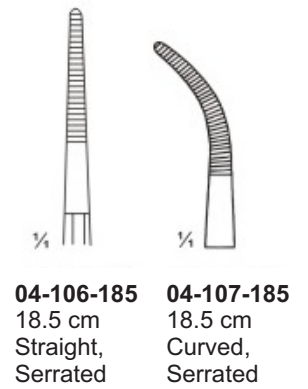

ADSON 1:2

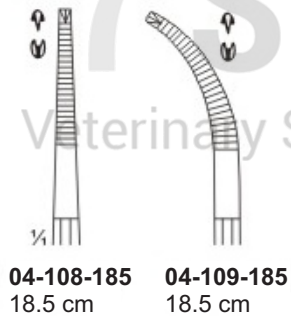

SAROT

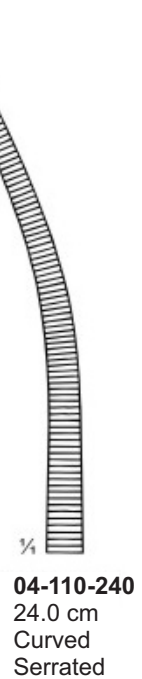

Haemostatic Forceps

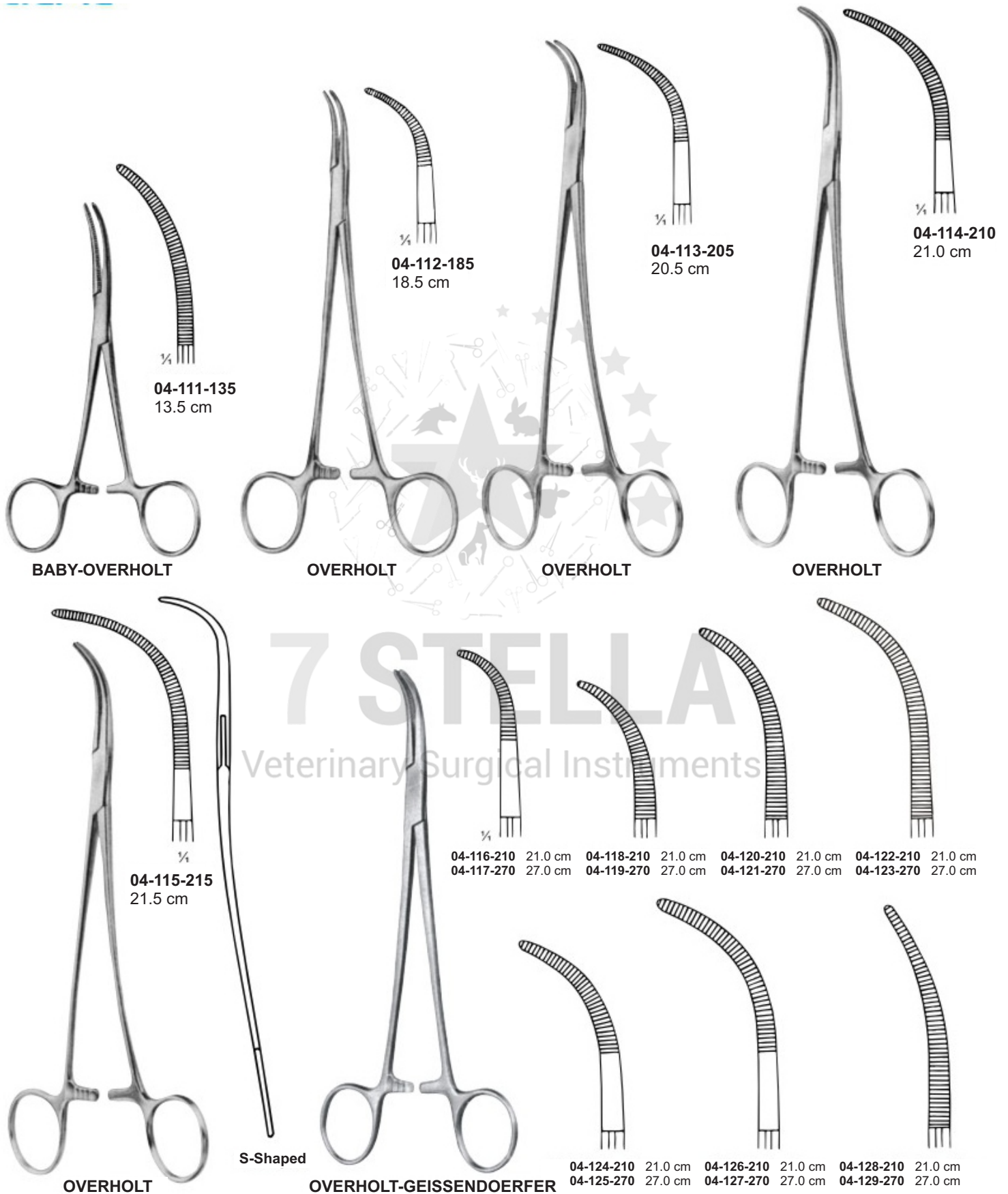

Haemostatic Forceps

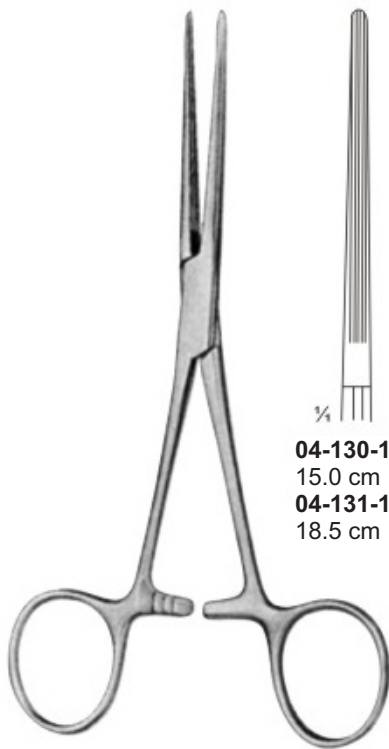

04-130-150
15.0 cm
04-131-185
18.5 cm

BAINBRIDGE



04-132-150
15.0 cm
04-133-185
18.5 cm

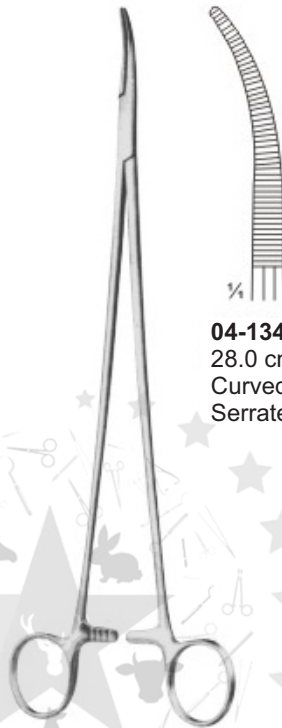

04-134-280
28.0 cm
Curved,
Serrated

BRIDGE

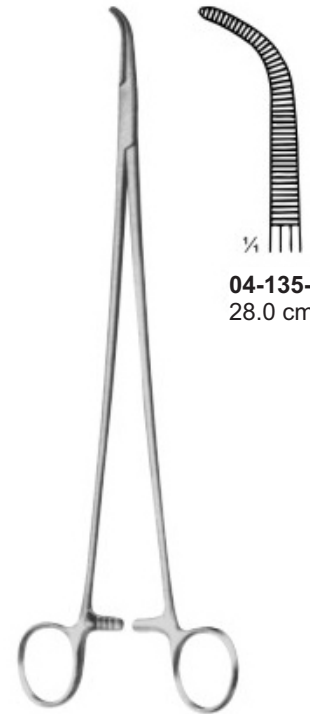

04-135-280
28.0 cm

LAWERCE



04-136-180
18.0 cm
Curved,
Serrated

MINI-GEMINI



04-137-130 13.0 cm
04-138-180 18.0 cm
04-139-200 20.0 cm
Curved, Serrated

GEMINI

Haemostatic Forceps



RUMEL
23.0 cm

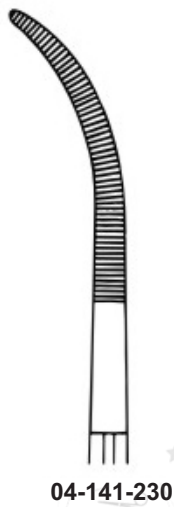
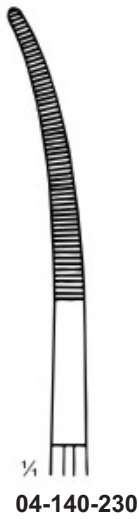

BENGOLEA

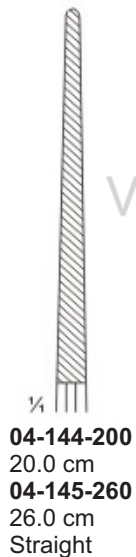

BENGOLEA 1:2

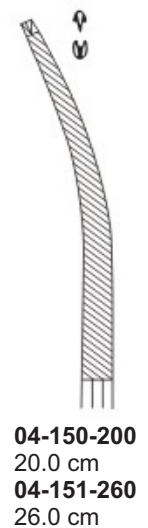

Haemostatic Forceps

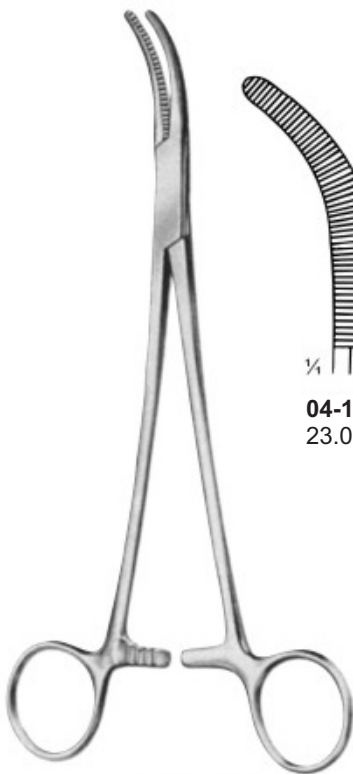

MOYNIHAN

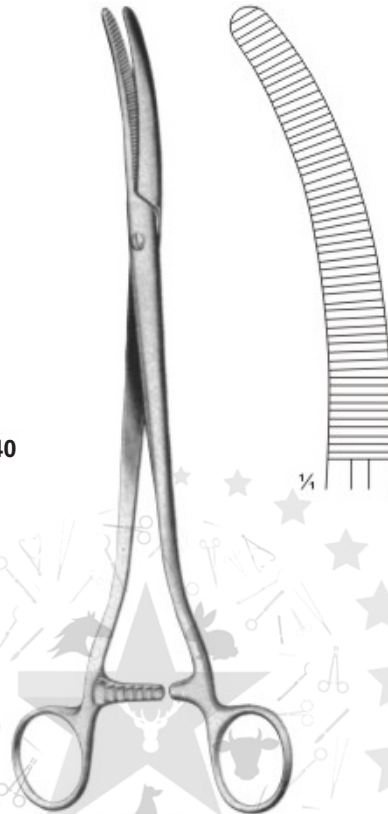
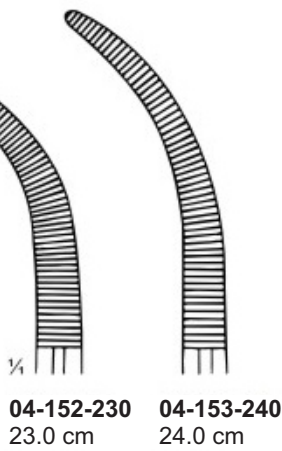

FAURE
04-154-250
25.0 cm

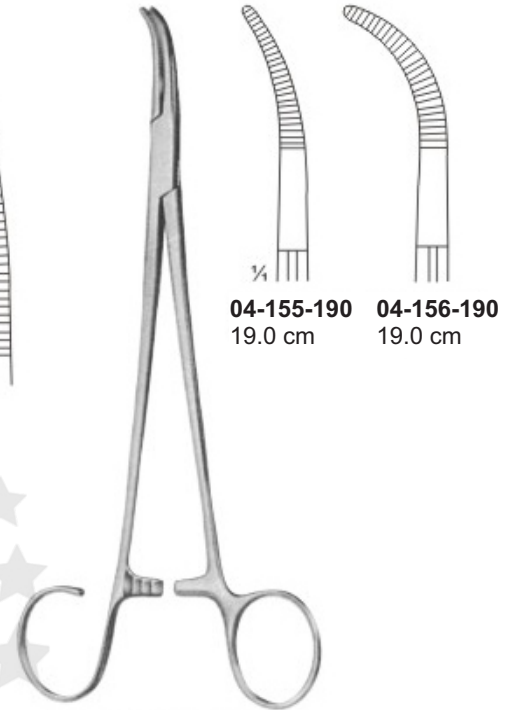

SCHNIDT-SAWTELL

04-155-190 19.0 cm 04-156-190 19.0 cm



TOENNIS

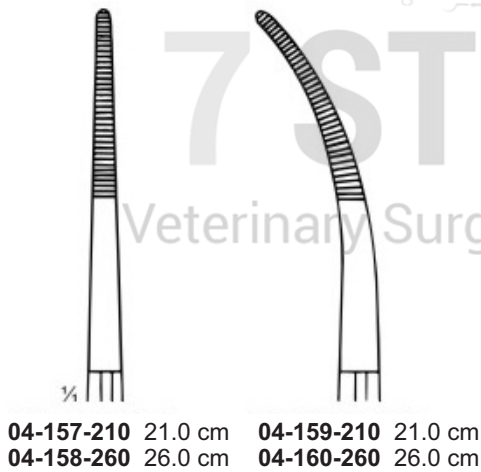

TOENNIS 1:2

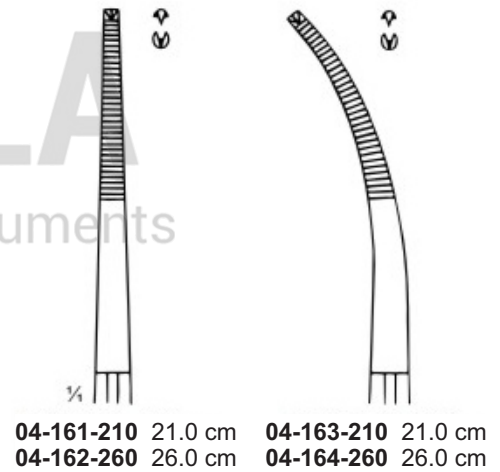

Haemostatic Forceps



04-165-140
14.0 cm
Curved,
Serrated

BABY-MIXTER



04-166-180
18.0 cm
Curved,
Serrated

BABY-MIXTER

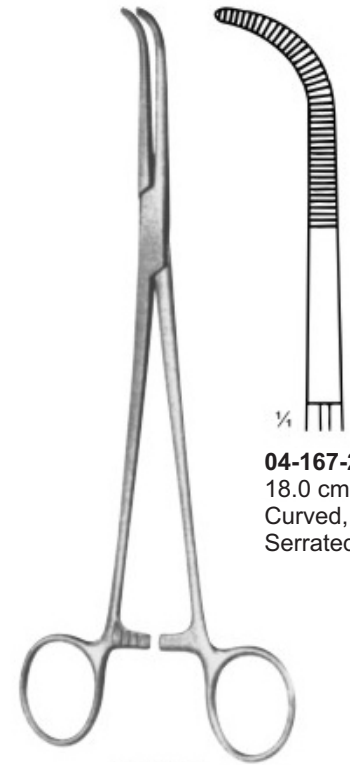

04-167-220
18.0 cm
Curved,
Serrated

MIXTER



04-168-210
21.0 cm
Right Angle
Grooves

MIXTER



04-169-155
15.5 cm
Fully Curved,
Serrated

MIXTER

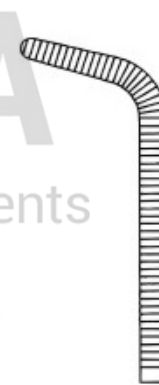

04-170-190
19.0 cm
Fully Curved,
Serrated

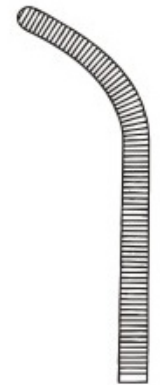

04-171-230
23.0 cm
Fully Curved,
Serrated

Haemostatic Forceps

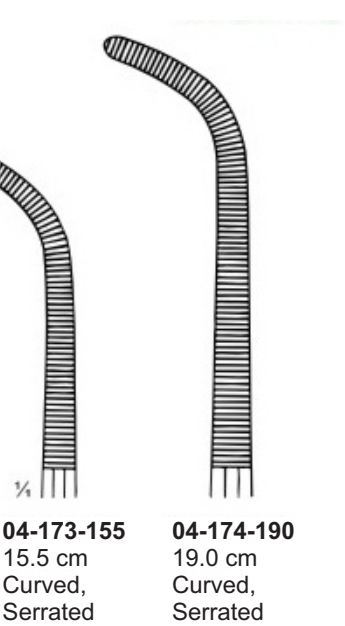
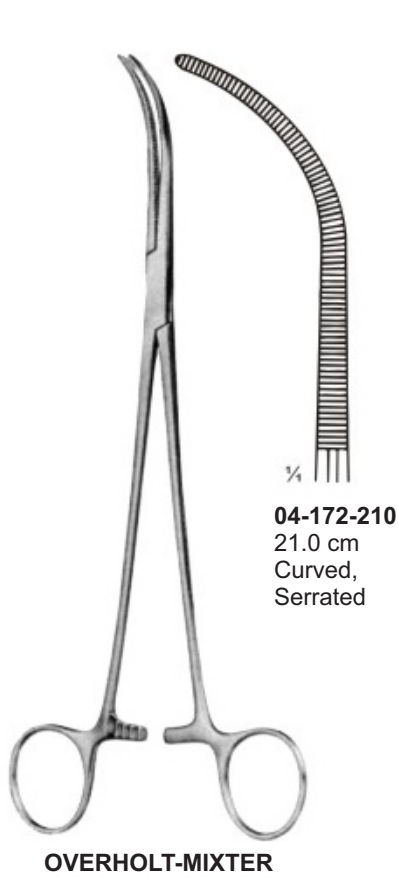

Haemostatic Forceps

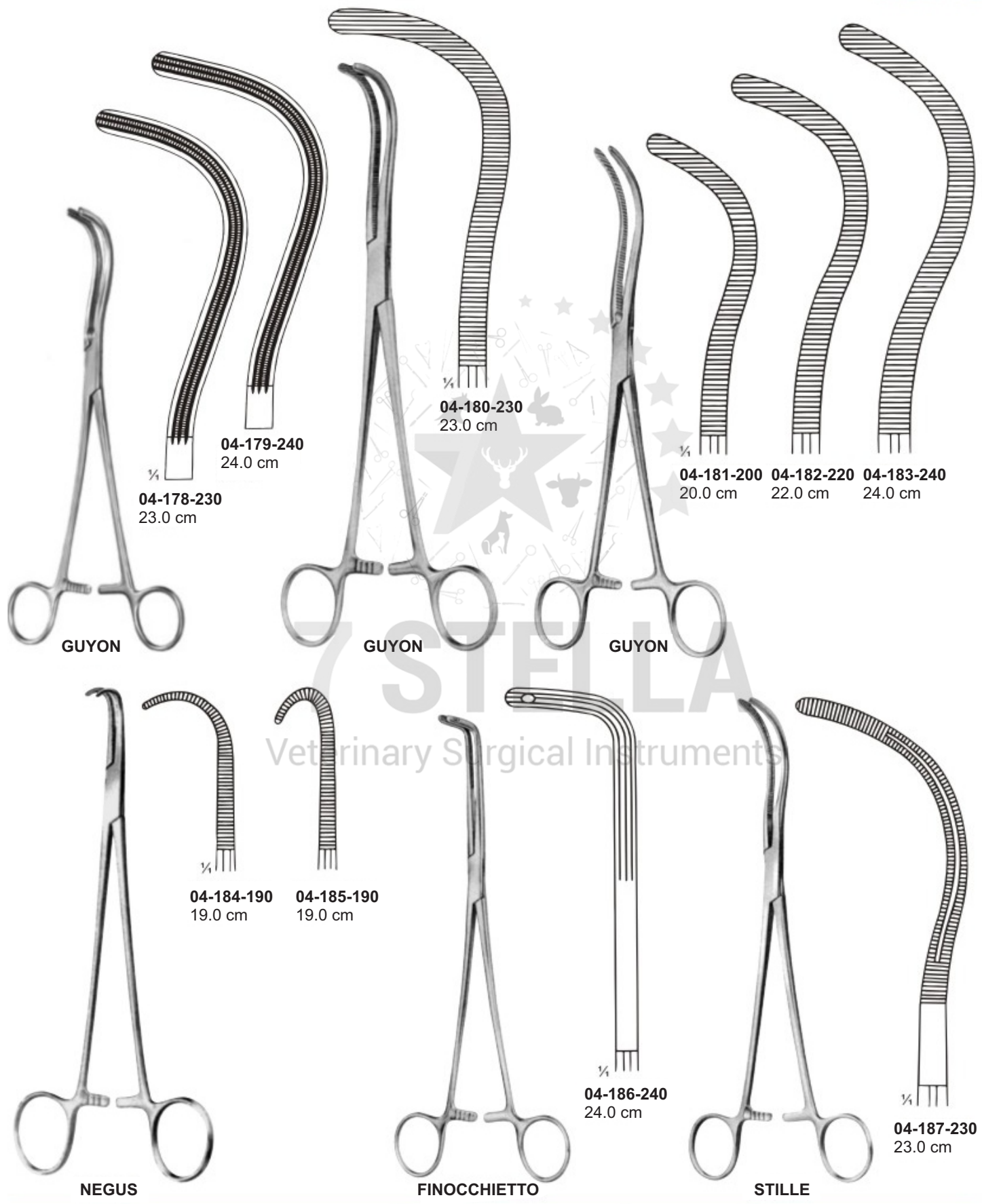

Haemostatic Forceps

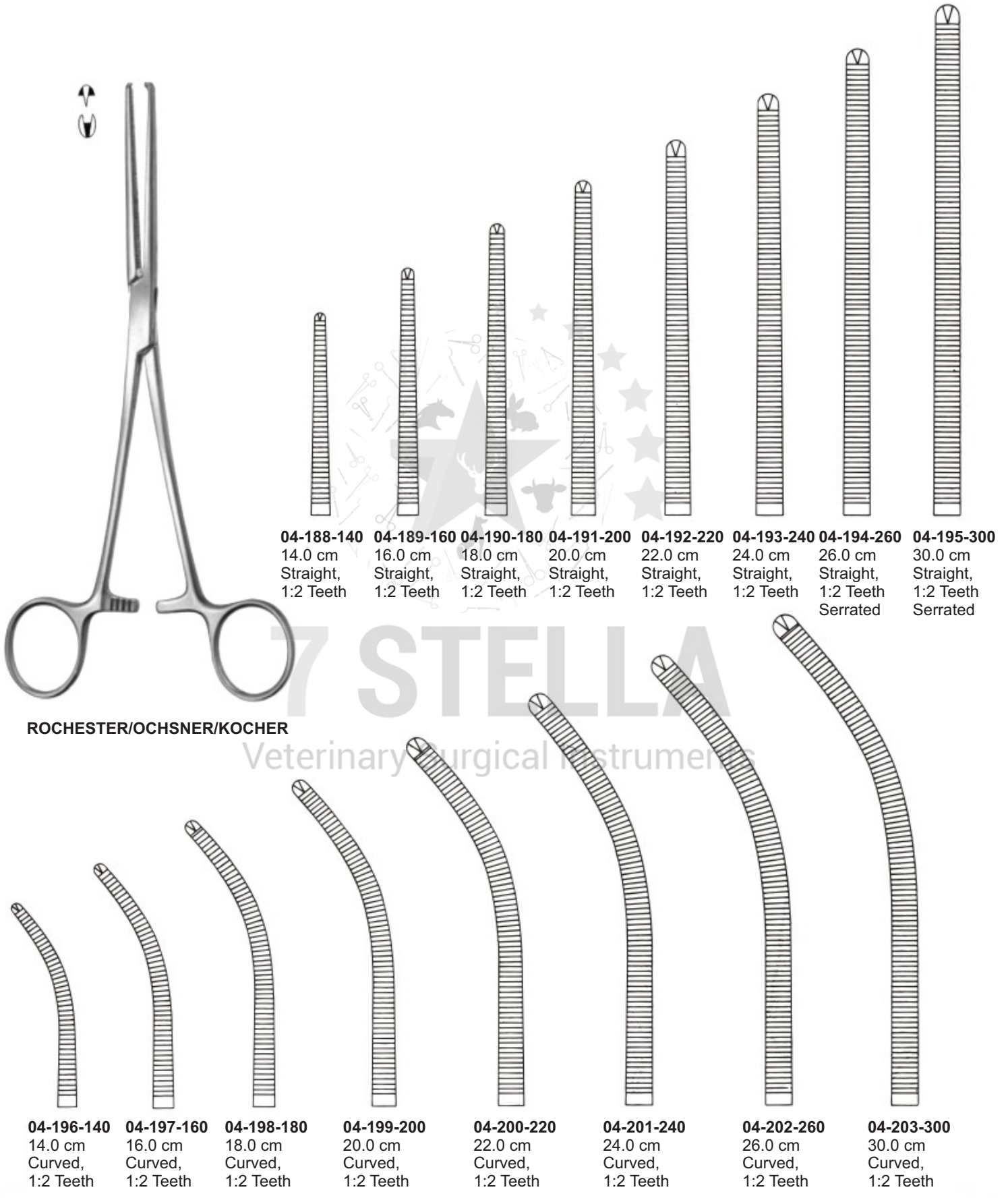

ROCHESTER/OCHSNER/KOCHER

- | | | | | | | | |
|--|--|--|--|--|--|--|--|
| 04-188-140
14.0 cm
Straight,
1:2 Teeth | 04-189-160
16.0 cm
Straight,
1:2 Teeth | 04-190-180
18.0 cm
Straight,
1:2 Teeth | 04-191-200
20.0 cm
Straight,
1:2 Teeth | 04-192-220
22.0 cm
Straight,
1:2 Teeth | 04-193-240
24.0 cm
Straight,
1:2 Teeth | 04-194-260
26.0 cm
Straight,
1:2 Teeth
Serrated | 04-195-300
30.0 cm
Straight,
1:2 Teeth
Serrated |
|--|--|--|--|--|--|--|--|

- | | | | | | | | |
|--|--|--|--|--|--|--|--|
| 04-196-140
14.0 cm
Curved,
1:2 Teeth | 04-197-160
16.0 cm
Curved,
1:2 Teeth | 04-198-180
18.0 cm
Curved,
1:2 Teeth | 04-199-200
20.0 cm
Curved,
1:2 Teeth | 04-200-220
22.0 cm
Curved,
1:2 Teeth | 04-201-240
24.0 cm
Curved,
1:2 Teeth | 04-202-260
26.0 cm
Curved,
1:2 Teeth | 04-203-300
30.0 cm
Curved,
1:2 Teeth |
|--|--|--|--|--|--|--|--|

Haemostatic Forceps

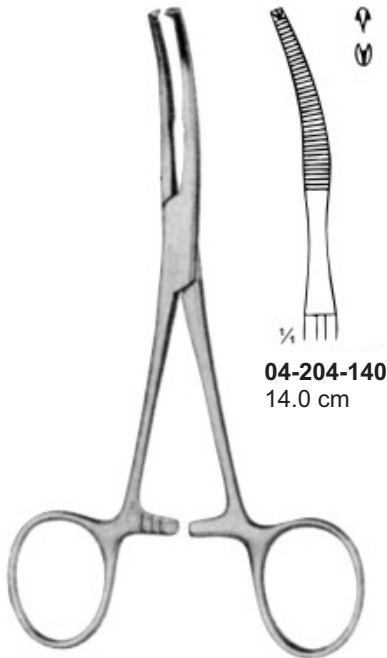

04-204-140
14.0 cm

BABY-MIKULICZ 1:2

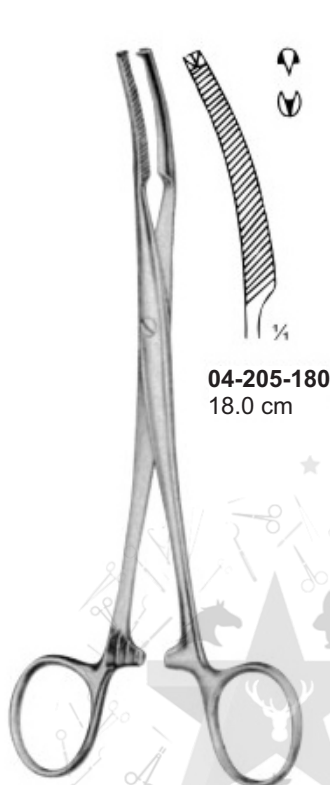

04-205-180
18.0 cm

MIKULICZ 1:2



04-206-200
20.0 cm

MIKULICZ 1:2



04-207-200
20.0 cm

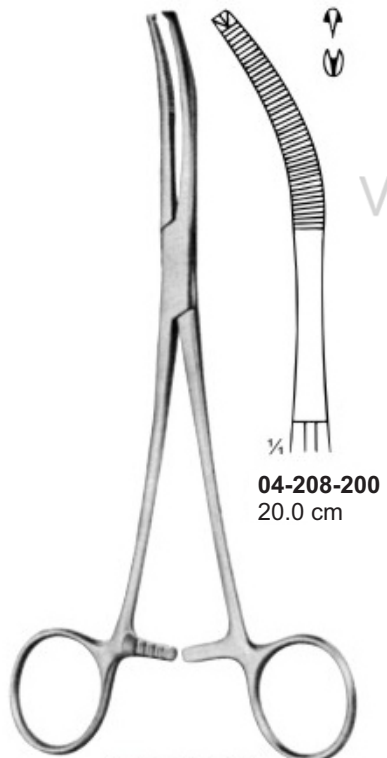

04-208-200
20.0 cm

MIKULICZ 1:2

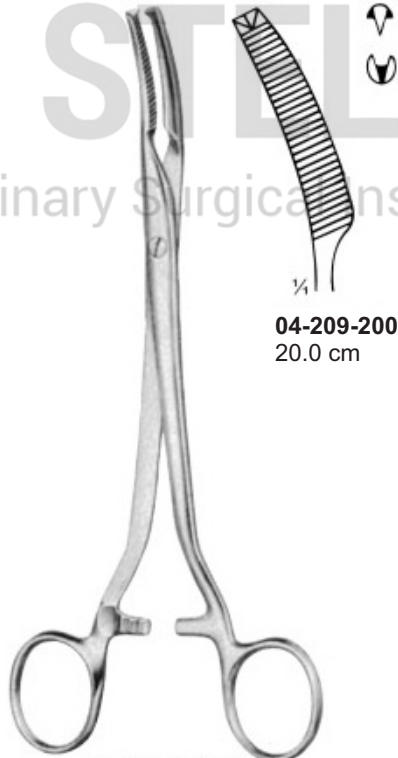

04-209-200
20.0 cm

MIKULICZ 1:2

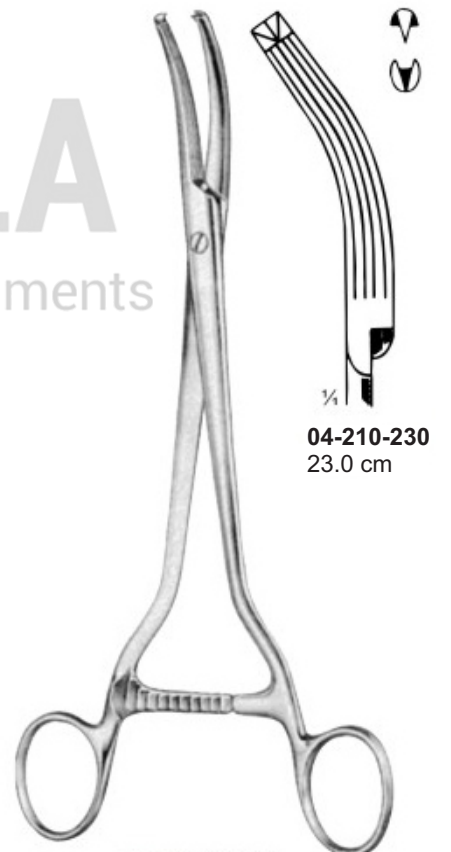

04-210-230
23.0 cm

MIKULICZ 1:2

Haemostatic Forceps



TUFFIER
04-211-130
13.0 cm



CHAPUT
04-212-130
13.0 cm



PENNINGTON / SIEZING

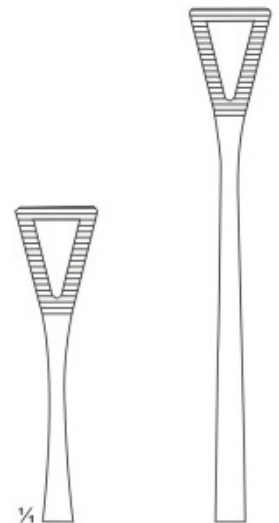

04-213-155
15.5 cm
Straight, 16mm

04-214-200
20 cm
Straight, 22mm



PRATT

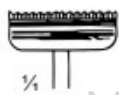

04-215-150
15.0 cm
Straight, Curve

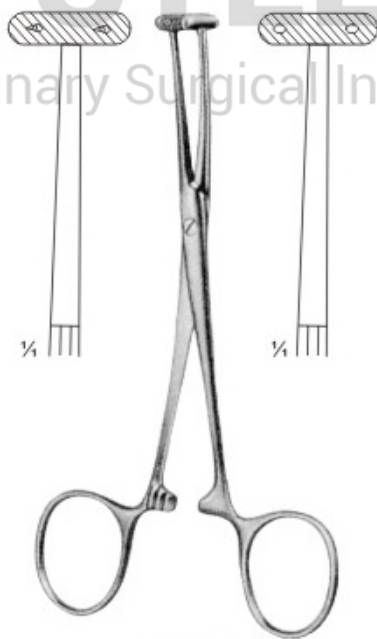

MARTEL
04-216-140
14.0 cm

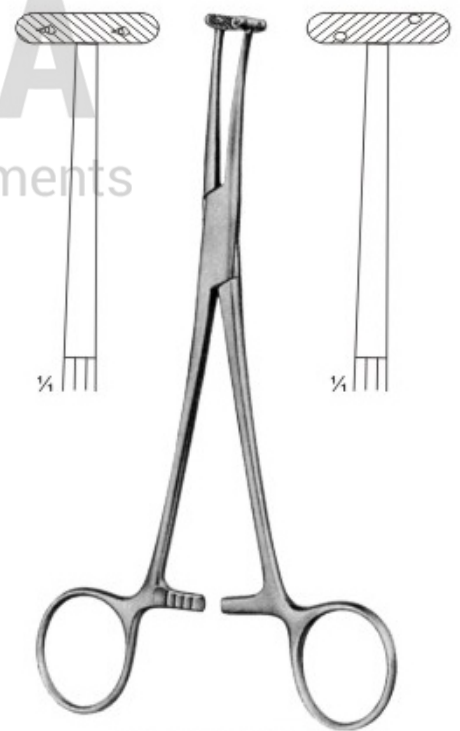

WILLET-MARTEL
04-217-10
19.0 cm

Towel Forceps



JONES / PERFORATING
04-218-090
9.0 cm
Slight Curve



ENGL. MODELL
04-219-090
9.0 cm



SCHAEFFEL
04-220-090
9.0 cm



SCHAEFFEL
04-221-180
18.0 cm

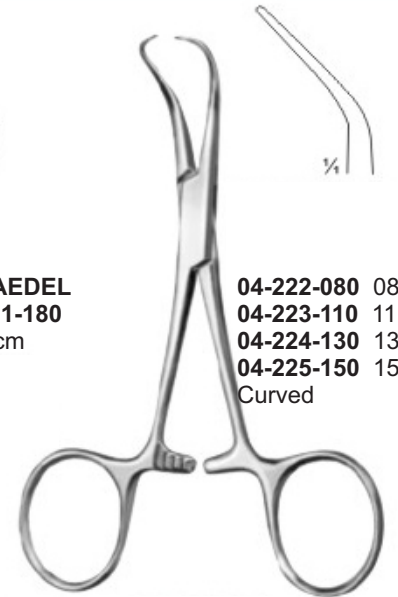

04-222-080 08.0 cm
04-223-110 11.0 cm
04-224-130 13.0 cm
04-225-150 15.0 cm
Curved

BACKHAUS



ROEDER

04-226-130
13.0 cm
Curved,
Serrated

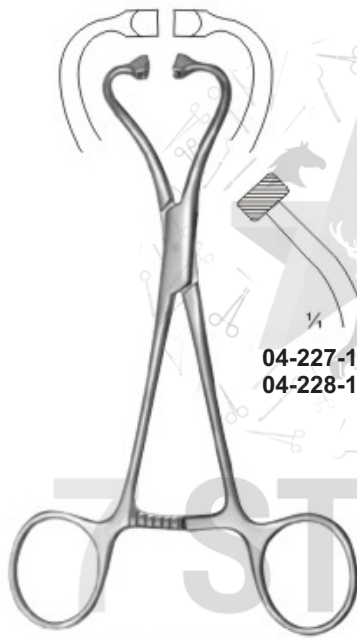

NON-PERFORATING

04-227-110 11.0 cm
04-228-130 13.0 cm

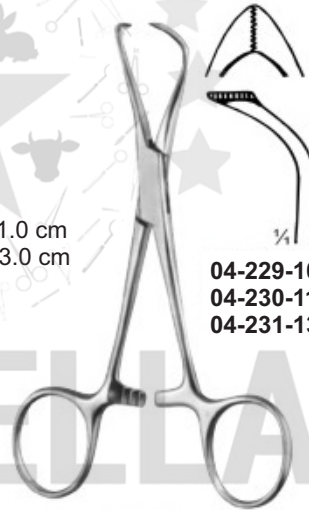

LORNA

04-229-100 10.0 cm
04-230-110 11.0 cm
04-231-130 13.0 cm

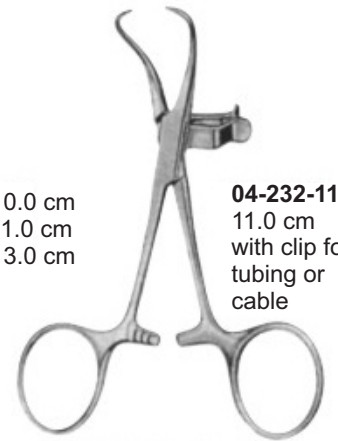

BACKHAUS CLIP

04-232-110
11.0 cm
with clip for
tubing or
cable



BALL & SOCKET

04-233-130
13.0 cm
Non-perforating

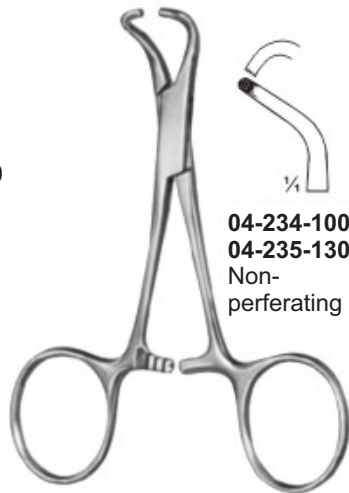

TOHOKU

04-234-100 10.0 cm
04-235-130 13.0 cm
Non-perforating

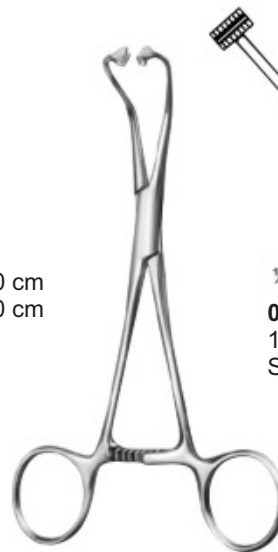

PEERS-BERTMAN

04-236-130
13.25 cm
Serrated



BERNHARD
04-237-165
16.5 cm